

# Temperature Controller E5C2

## DIN-sized (48 x 48 mm) Temperature Controller with analogue setting



- Compact, price effective Temperature Controller.
- Incorporates proportional control and reset adjustment function.
- Consecutive mounting possible using mounting adapter.
- Incorporates a plug-in socket, allowing DIN-track and flush mounting.



For the most recent information on models that have been certified for safety standards, refer to your OMRON website.

Refer to *Safety Precautions for All Temperature Controllers*.

## Model Number Structure

### Model Number Legend

E5C2- □ □ □ □  
1 2 3 4 5

#### 1. Control Outputs

R: Relay

#### 2. Control Method

20: ON-OFF control

40: Proportional control

#### 3. Input

K: K-type thermocouple

J: J-type thermocouple

P-D: Platinum resistance thermometer (Pt100)

G: Thermistor with replaceable element

#### 4. Power supply voltage:

AC100-240: 100 to 240 VAC

#### 5. Temperature range

E.g. "0-200": 0 to 200 °C

**Note:** A functional explanation is shown in the below table: But models are not necessarily available for all possible combinations. Refer to *Ordering Information* when ordering.

#### Examples

- Relay control output, ON/OFF control, K-type thermocouple input, 100 to 240 VAC power supply voltage, 0 to 200 °C: E5C2-R20K AC100-240 0-200
- Relay control output, proportional control, Relay control output, K-type thermocouple, 100 to 240 VAC power supply voltage, 0 to 800 °C: E5C2-R40K AC100-240 0-800

## Ordering Information

### Temperature Controllers

Input					Thermocouple						Resistance Thermometer						Thermistor		
					K (CA) Chromel vs. alumel			J (IC) Iron vs. constantan			Platinum resistance thermometer Pt100						Thermistor (replaceable element)		
Setting method	Indication method	Control mode	Output	Minimum scale division (°C)	Standard scale (°C)												Thermistor nominal		
					200	400	600	800	1,000	1,200	200	300	400	50	50	100	200	300	400
5	10	20	20	25	25	5	10	10	2	1	2	5	10	10	2	2	2		
Analog setting	No indication	ON/OFF	Relay	Model	E5C2-R20K			E5C2-R20J			E5C2-R20P-D						E5C2-R20G		
		Proportional (P)	Relay	Model	E5C2-R40K			---			---						---		

**Note:** When placing an order, specify the temperature range in addition to the model number.

## Standard Models (Power supply: 100-240 VAC)

Input			Indication method	No indication		
				Control method	ON/OFF	Proportional (P)
			Output	Relay		
Input/ standard scale (°C)	Thermocouple	K (CA) Chromel vs. Alumel	0 to 200°C	E5C2-R20K AC100-240 0-200	E5C2-R40K AC100-240 0-200	
			0 to 300°C	–	E5C2-R40K AC100-240 0-300	
			0 to 400°C	E5C2-R20K AC100-240 0-400	E5C2-R40K AC100-240 0-400	
			0 to 600°C	E5C2-R20K AC100-240 0-600	E5C2-R40K AC100-240 0-600	
			0 to 800°C	E5C2-R20K AC100-240 0-800	E5C2-R40K AC100-240 0-800	
			0 to 1000°C	E5C2-R20K AC100-240 0-1000	–	
			0 to 1200°C	E5C2-R20K AC100-240 0-1200	–	
		J (IC) Iron versus Constantan	0 to 200°C	E5C2-R20J AC100-240 0-200	–	
			0 to 300°C	E5C2-R20J AC100-240 0-300	–	
			0 to 400°C	E5C2-R20J AC100-240 0-400	–	
		Resistance thermometer	Platinum resistance thermometer	–50 to 50°C	E5C2-R20P-D AC100-240 -50-50	–
				0 to 50°C	E5C2-R20P-D AC100-240 0-50	–
				0 to 100°C	E5C2-R20P-D AC100-240 0-100	–
				0 to 200°C	E5C2-R20P-D AC100-240 0-200	–
	0 to 300°C			E5C2-R20P-D AC100-240 0-300	–	
	0 to 400°C			E5C2-R20P-D AC100-240 0-400	–	
	Thermistor	THE (replaceable element)	0 to 100°C	E5C2-R20G AC100-240 0-100	–	
			100 to 200°C	E5C2-R20G AC100-240 100-200	–	
			150 to 300°C	E5C2-R20G AC100-240 150-300	–	

## ■ Accessories (Order Separately)

### Sockets

Name	Model
Front Connecting Socket	P2CF-08
Back Connecting Socket	P3G-08
Front Connecting Socket with Finger Protection	P2CF-08-E
Protective Cover (for finger protection)	Y92A-48G

### Protective Cover

Type	Model
Hard Protective Cover	Y92A-48B

# Specifications

## ■ Ratings

<b>Supply voltage</b>	100 to 240 VAC 50/60 Hz
<b>Operating voltage range</b>	90% to 110% of rated supply voltage
<b>Power consumption</b>	Approx. 3.6 VA
<b>Input</b>	Thermocouple (with sensor burnout detection circuit), platinum resistance thermometer, or thermistor with replaceable element
<b>Control method</b>	ON/OFF or proportional control
<b>Setting method</b>	Analog setting
<b>Indication method</b>	No indication
<b>Control output</b>	Relay output: SPDT, 3 A at 250 VAC, resistive load (switching capacity: 330 VA)
<b>Ambient operating temperature</b>	-10°C to 55°C (with no icing or condensation)
<b>Ambient operating humidity</b>	45% to 85%

**Note: 1.** Do not use an inverter output as the power supply. (Refer to *Safety Precautions for All Temperature Controllers.*)

## ■ Connections

### Connecting the Input

- Connect a thermocouple, the E52-THE□ Thermistor (replaceable element) or a platinum resistance thermometer to terminals 1 (positive) and 2 (negative) on the E5C2 as shown in the following illustration.

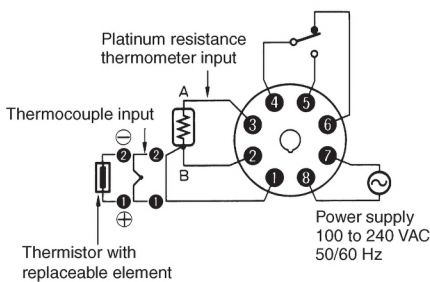

- On the E52-□□1D, the lead wires are thermocouple element wires, making them difficult to solder because solder will not stick to them easily. Remove the crimp terminal and polish the ends before attempting to solder them.

## ■ Characteristics

<b>Setting accuracy</b>	±2% FS max.
<b>Hysteresis</b>	Approx. 0.5% FS (fixed)
<b>Proportional band</b>	3% FS (fixed)
<b>Control period</b>	Approx. 20 s
<b>Reset range</b>	5 ±1% FS min. (See note 1.)
<b>Insulation resistance</b>	20 MΩ min. (at 500 VDC)
<b>Dielectric strength</b>	2,000 VAC, 50/60 Hz for 1 min between charged terminals and uncharged metallic parts
<b>Vibration resistance</b>	Malfunction: 10 to 55 Hz, 0.15-mm single amplitude for 10 min each in X, Y, and Z directions Destruction: 16.7 Hz, 2-mm double amplitude for 2 hrs each in X, Y, and Z directions
<b>Shock resistance</b>	Malfunction: 147 m/s <sup>2</sup> , 3 times each in 6 directions Destruction: 294 m/s <sup>2</sup> , 3 times each in 6 directions
<b>Life expectancy</b>	Electrical: 100,000 operations min. (3 A at 110 VAC, resistive load)
<b>Weight</b>	Approx. 100 g (with flush-mounting adapter)
<b>Degree of protection</b>	Front panel: IEC standard IP40 (See note 2.) Terminals: IEC standard IP00
<b>Applicable Socket</b>	P2CF-08 (order separately), P3G-08 (order separately)
<b>Applicable Protective Cover</b>	Y92A-48B (order separately)

- Note: 1.** No reset function is incorporated by any E5C2 model with ON/OFF control.  
The reset function is used to correct offset for proportional control. If there is an offset below the set value, turn the reset adjustment clockwise.
- 2.** A special Watertight Cover is used to achieve this degree of protection (IP66, NEMA4). Refer to Y92A-□□N.

### Output

- If the load circuit is a heating control system, be sure to connect the load to terminals 4 and 5. If the load circuit is a cooling control system, be sure to connect the load to terminals 4 and 6.
- We recommend using an external relay to extend the electrical life of internal relays when driving a large capacity load. This is particularly important when the output relay is switched frequently (e.g., with proportional control).

### Power Supply

- If a single power supply is used for the E5C2 and the load, the supply voltage of the power supply may vary greatly when the load is open or closed if the capacity of the power supply is not large enough. Make sure that the capacity of the power supply is large enough so that the supply voltage range will be always from 90% to 110% of the rated supply voltage.
- The E5C2 operates at either 50 or 60 Hz.

# Nomenclature

Temperature setting knob

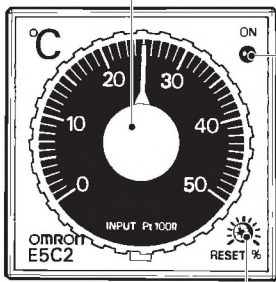

Operation indicator

RESET adjustment shaft  
No reset function is incorporated by any E5C2 model with ON/OFF control.

## Operation Indicator

Indicator		Output	
		NO contacts (4 and 5)	NC contacts (4 to 6)
Red	Lit	ON	OFF
	Not lit	OFF	ON



# Dimensions

Note: All units are in millimeters unless otherwise indicated.

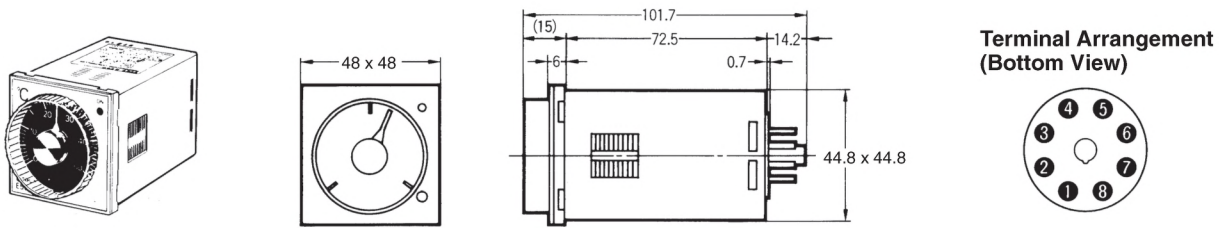

## Dimensions with Flush-mounting Adapter (Accessory), and Back Connecting Socket (Sold Separately)

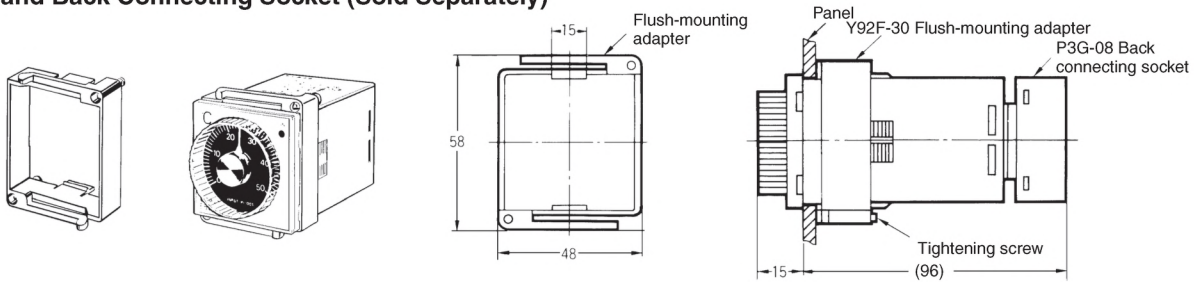

### Panel Cutout

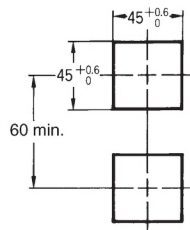

### Side-by-side Mounting of N Controllers

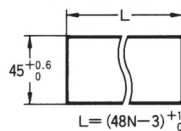

Qty.	2	3	4	5	6
L	93 <sup>+1</sup> <sub>0</sub>	141 <sup>+1</sup> <sub>0</sub>	189 <sup>+1</sup> <sub>0</sub>	237 <sup>+1</sup> <sub>0</sub>	285 <sup>+1</sup> <sub>0</sub>

- Note: 1. Recommended panel thickness is 1 to 4 mm.  
2. Close side-by-side mounting is possible (in a single direction).

## Accessories (Order Separately)

### Connection Sockets

#### P2CF-08 Front Connecting Socket

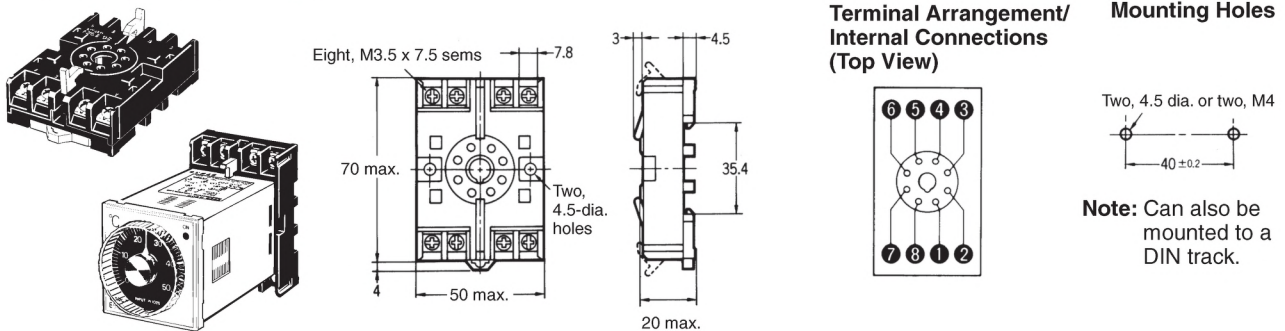

Note: A finger-protection model (P2CF-08-E) is also available.

#### P3G-08 Back Connecting Socket (for Flush Mounting)

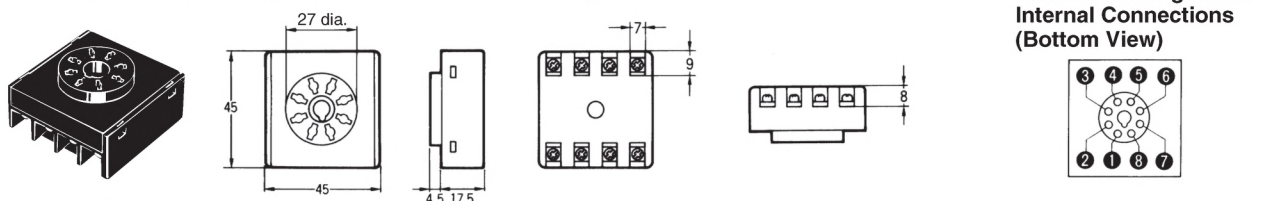

Note: A Protective Cover for finger protection (Y92A-48G) is also available.

---

## Hard Protective Cover

A Hard Protective Cover (Y92A-48B) is available. It can be used in the following cases.

- To protect the setting section, against dust and dirt
- To prevent accidentally changing settings by touching the front of the Controller.
- To protect the Controller from water drips

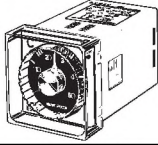
<b>Appearance</b>	
<b>Model</b>	Y92A-48B

## Applicable Thermistor

Connect a Thermistor with a replaceable element (E52-THE5A, E52-THE6D, or E52-THE6F) to the E5C2-R20G. Refer to *E52* for details.

# Safety Precautions

Refer to *Safety Precautions for All Temperature Controllers*.

## ■ Correct Use

### Mounting

#### Track Mounting (E5C2 with P2CF-08)

When mounting two or more E5C2 models with track-mounting sockets, leave a space of approximately 20 mm on both sides of the sockets where hooks are located.

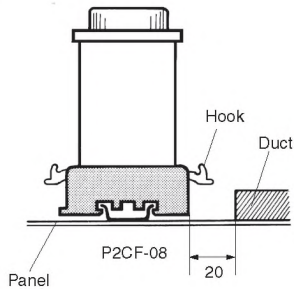

#### Flush Mounting

Insert E5C2 into the square hole of the panel and insert an adapter from the back so that there will be no space between E5C2 and the panel. Then, secure the E5C2 with a screw.

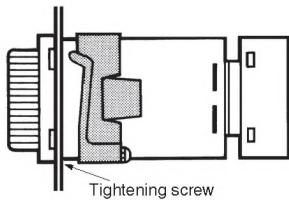

The P3G-08 can be wired in the same way as the P2CF-08.

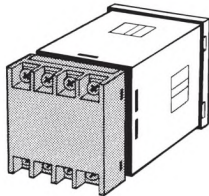

### Dismounting

If flush mounted, loosen the screw of the adapter and disengage the hooks for dismounting.

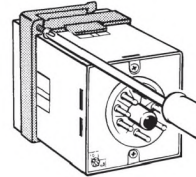

### Temperature Setting

Do not turn the temperature setting knob of the E5C2 with excessive force, otherwise the stopper of the knob may break.

### Others

- Do not remove the housing of the E5C2, otherwise the housing may break.
- To clean the surface of the E5C2, use a soft cloth wet with neutral detergent or alcohol. Do not use any organic solvent, such as paint thinner or benzene, strong acid or strong alkali to clean the surface of the E5C2, otherwise the surface of the E5C2 will become damaged.

ALL DIMENSIONS SHOWN ARE IN MILLIMETERS.

To convert millimeters into inches, multiply by 0.03937. To convert grams into ounces, multiply by 0.03527.

In the interest of product improvement, specifications are subject to change without notice.