

NEW

Smart Sensor

Wide Laser Beam CCD Measurement Sensor ZX-GT

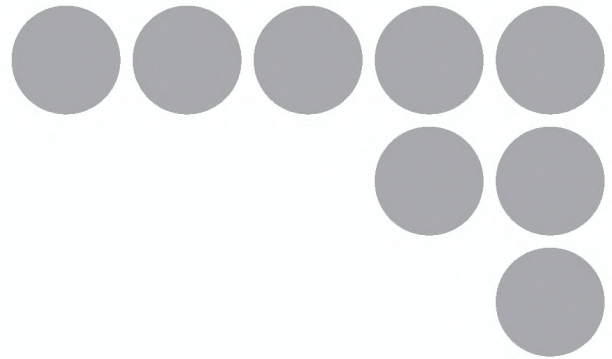

10- μ m Accuracy by 500-mm Range

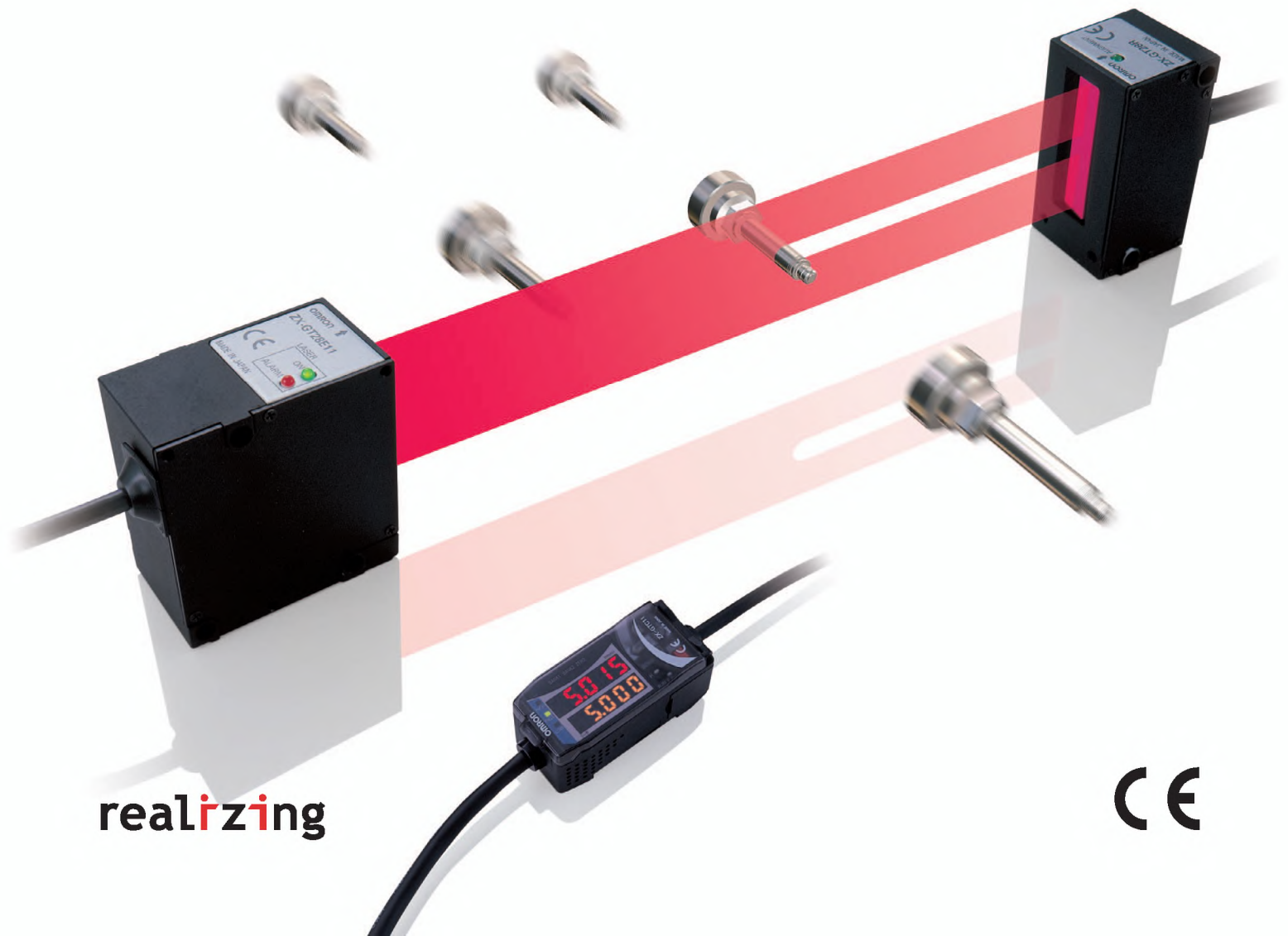

realizing



New Standards for Dimension Measurement



First in its class

Measurable at any position

The usual limitations, such as the 'measurement area being confined to the center' or 'large errors due to positioning', that used to plague laser measuring sensors have now been overcome. Measurements can be consistently taken within a 500 mm area, whatever stage the work is at or whichever way it is inserted. It can now be set to positions without interference from the work feed and without limitations of size of work area.

What does "10-micron by 500-mm" mean?

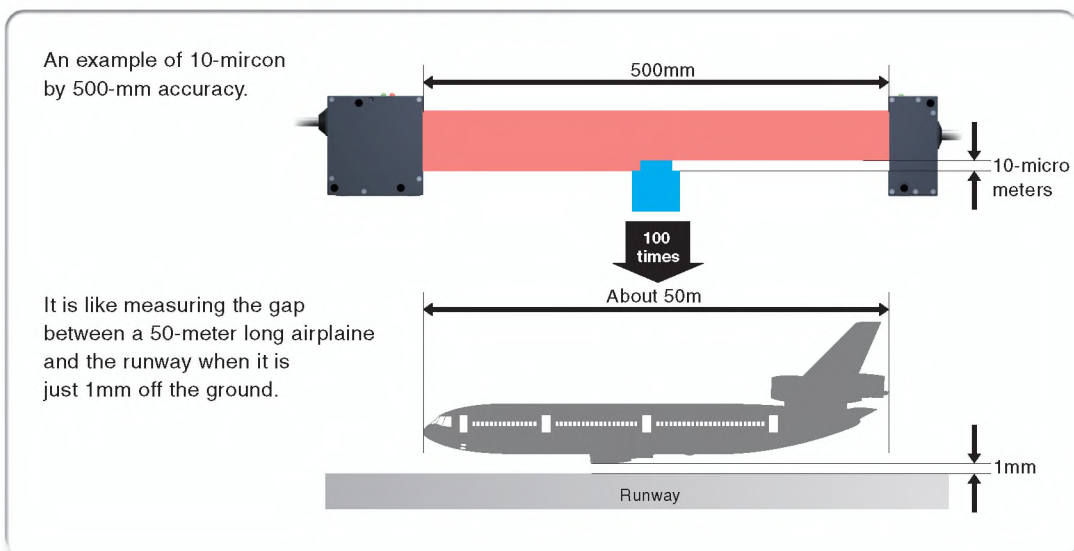

00mm

CCD and TRIO algorithm

(Two-thirds actual size)

One of the best in its class

10- μ m by non-contact method

ZX-GT is the only sensor with the ability to measure and locate position to an accuracy of 10 μ m without contact. Unlike conventional through-beam laser sensors, the ZX-GT's unique algorithm has the flexibility to meet a wide variety of applications, including the ability to accurately measure glass and mirror surfaces.

One of the fastest in its class

1/7 in speed compared with conventional products

With OMRONS unique TRIO (Triple parallel processing) algorithm, it is possible to take 2000 high-speed samples per second, 7 times greater than previously possible, greatly reducing tact time.

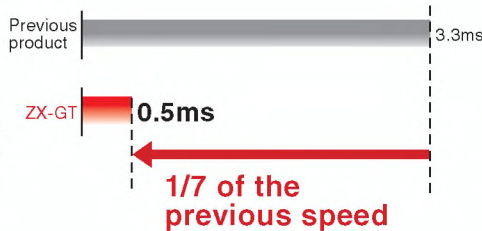

New concept TRIO structure

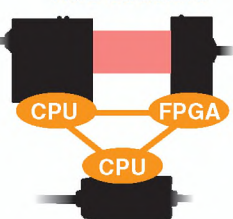

One of the smallest in its class

Compact like palm-top

The controller, a continuation of the ZX series, is the smallest in its class. Combined with its compact sensor head, it is ideal for integration into various equipments.



Compact sensor head that can be set in the gap between equipment.



Its compact controller is a continuation of the ZX series.

(Class definition as of May 5th, 2007, according to our investigations.)

Cutting-edge laser technology

Strong temperature compensation

It is important to eliminate the influence of temperature to ensure the accuracy of a measurement. However, the temperature in the field environment changes according to the time and the season. With the ZX-GT, which employs CCD method, the influence on the resolution from temperature changes is greatly reduced leading to an error rate as low as 0.01% (2.8 micro-meters*).

*This is a representative case. Please see the specifications table for the details of the relevant conditions.

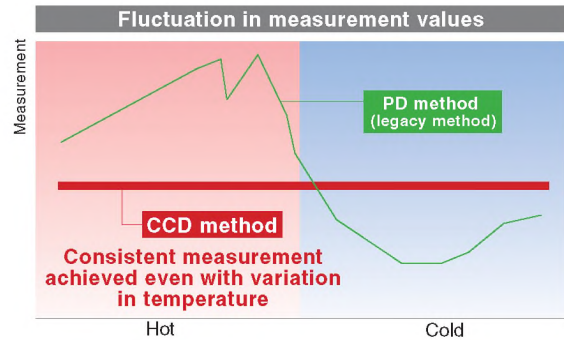

Dedicated glass-detection function Integrated MRC filter Patent pending

The detection of edges has been a problem for transparent objects with traditional transmission type sensors. However, ZX-GT adopts OMRON's unique MRC filter (Mirror Reflection Cut Filter) and CCD methodology. It can accurately detect work that reflects light such as mirror-finished surface or work that allows light to pass through such as glass (including coated glass).

*MRC Filter: OMRON's proprietary optical filter.

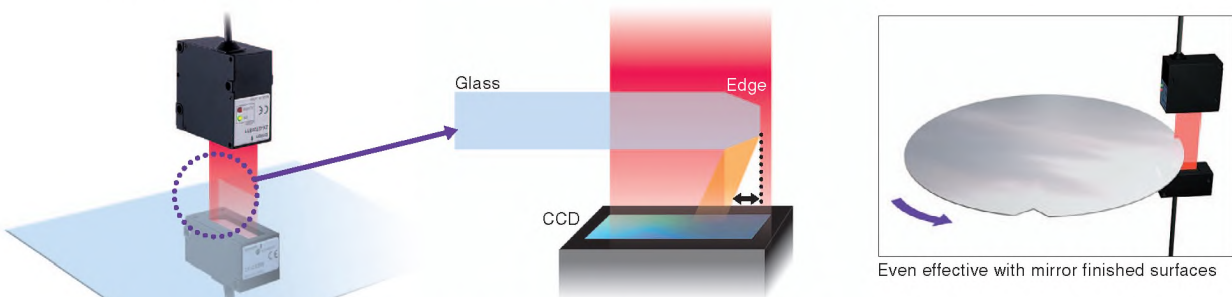

Glass-edge measurement

CCD elements detects a slight shadow created when a laser light hits the edge of the glass to determine the position of the edge.

Collimate optical technology

Super parallel-beam

With OMRON's unique collimate optical technology, the closest to ideal parallel beam is created. Errors are controlled in the measurement area and the longest and most accurate measurement is achieved.

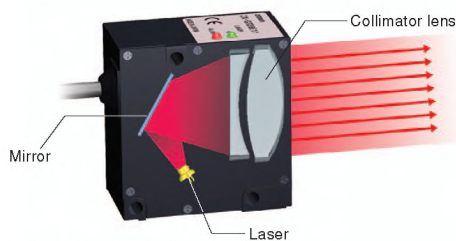

*Collimate optical technology

Collimate optical technology allows laser lights to stay parallel using mirror reflection and lens refraction effects, to take advantage of the laser light's high-level of directivity.

Sub-pixel processing

CCD processing algorithm

CCD detects the shadow made from measurement objects and by performing sub-pixel calculation, it achieves 10 micrometer level accuracy.

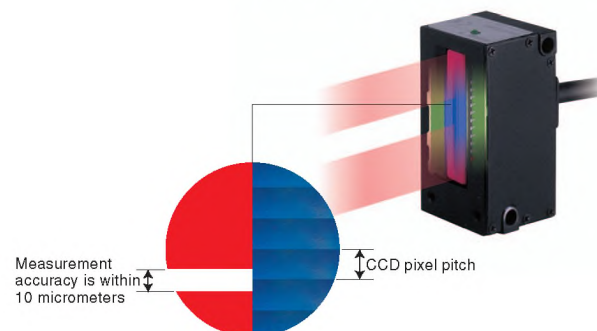

Applications by industry

Automotive & Automotive-components <Outer diameter measurement>

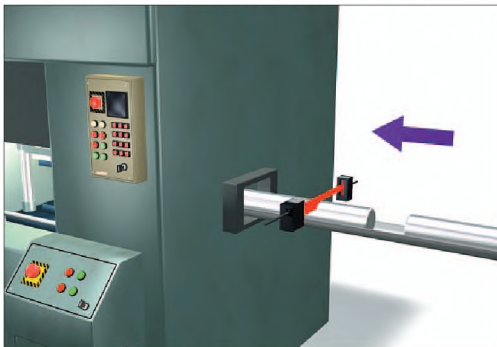

Diameter measurement of metal objects

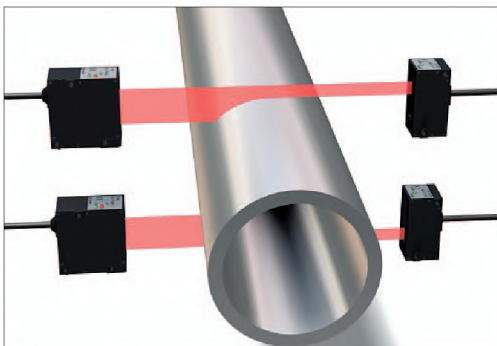

Diameter measurement of large-scale pipe

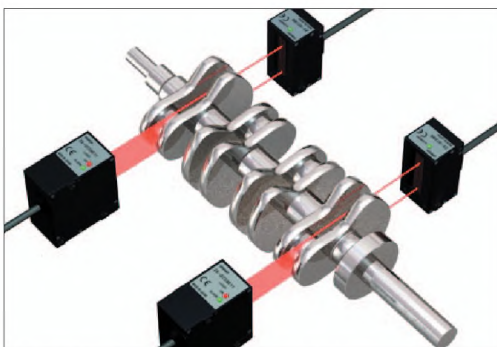

Diameter measurement of crank shaft

LCD & PDP

<Glass-edge measurement>

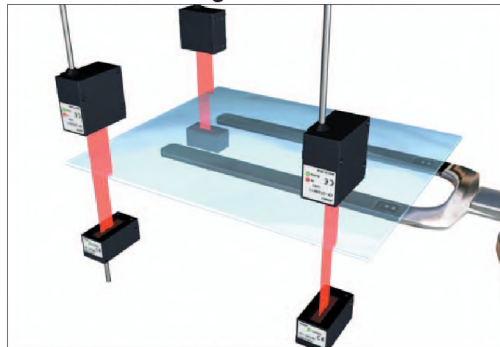

Glass alignment for the FPD industry

Semiconductor

<Insertion-amount measurement>

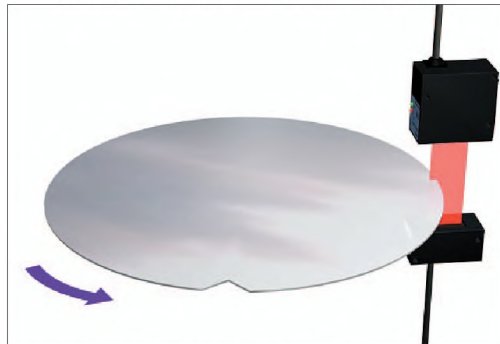

Notch position detection of glass wafer

Electronic components

<Lead-pitch and diameter measurement>

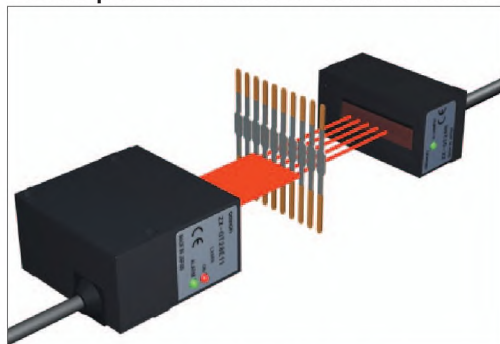

Width and spacing inspection of leadframe

Longer, but Easy-to-use

New Concept

"Smart Recipe"

Using the PC software 'Smart-monitor GT', set up is easy with simply clicking the icons. This is OMRON's Smart Recipe methodology.

Interface Unit

By connecting it to the controller, RS-232C communication and binary output is possible.

Controller

Easy to set-up

Different features are organized by tabs, to allow the user to understand and change the settings easily. Measurement conditions can be saved on PCs.

Strong support tool

The measurement data is gathered in the PCs in real time so it is easy to ascertain and analyse the current conditions at any time.

● Grasp the data trend and prevent defective parts

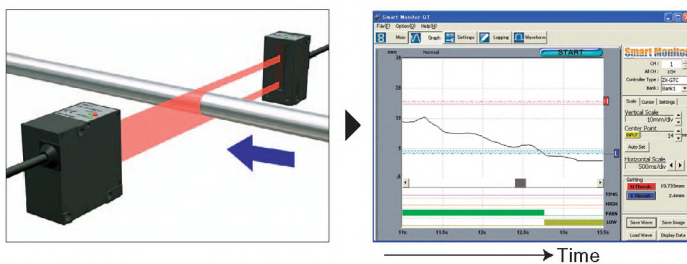

The trend of the measurement data and sudden change can be checked in the time-dependent graph, so that the appropriate action can be taken before defective goods are produced.

● Measurement result can be logged at appropriate times

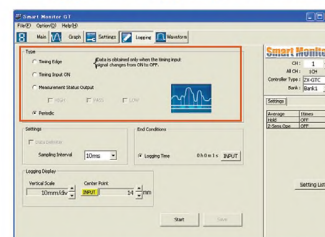

The logged data can be sent to Excel. It is useful for traceability management and for preparing quality assurance reports.

First in the industry Patent pending

3-way optical axis adjustment

Three optical axis adjustment functions are integrated for the industry's longest measurement. This function provides the optimal adjustment when the sensor head is installed on-site.

With the sensor-head



LED on the light-receiving device is lit up to indicate when the light axis is matched.

With the controller



The CCD light reception balance is displayed in the upper display and the amount of light received can be confirmed with numerical values underneath.

With the PC



The direction of the sensor head's adjustment is graphically displayed. The adjustment conditions can be confirmed through the shapes of the light reception waveforms.

Longest in the industry

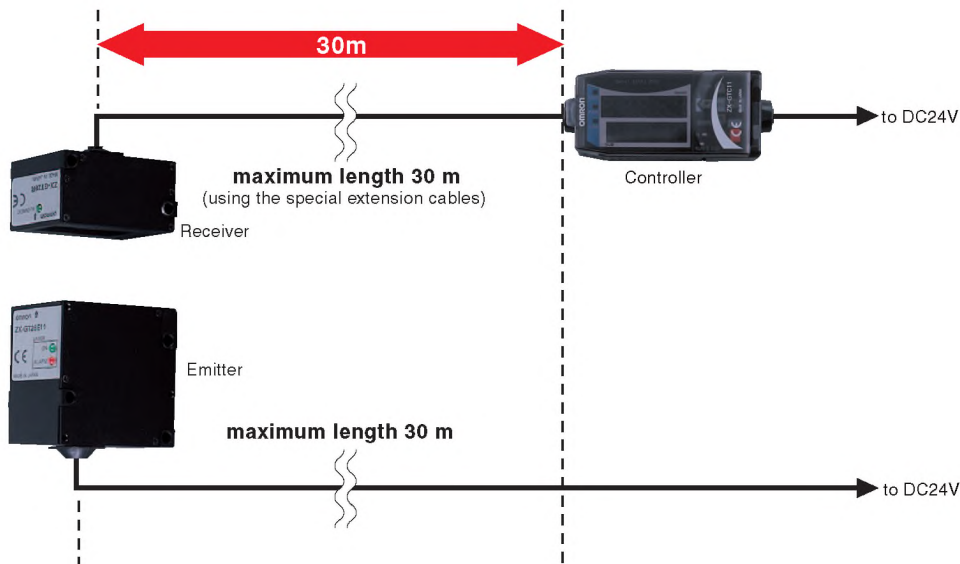

30-m cable extension

The emitter and receiver do not need to be connected with each other. Each cable can be extended up to 30 m. It is perfectly suited for installation into large-scale production line.



Ordering Information

Sensor

Appearance	Optical system	Measuring width	Sensing distance	Resolution	Output type	Model
Separate type 	Through-beam	28mm	0 to 500mm	10μm	NPN	ZX-GT28S11
					PNP	ZX-GT28S41
Integrated type 			NPN		ZX-GT2840S11	
			PNP		ZX-GT2840S41	

Controller

Appearance	Power supply	Output type	Model
	DC	NPN	ZX-GTC11
		PNP	ZX-GTC41

Accessories(Order Separately)

Set of Interface Unit and Setup software PCs

Output type	Model
NPN	ZX-GIF11A
PNP	ZX-GIF41A

Interface Unit(RS-232C/Binary output)

Appearance	Power supply	Output type	Model
	DC	NPN	ZX-GIF11
		PNP	ZX-GIF41

Setup software PCs

Name	Model
Smart Monitor GT	ZX-GSW11

Calculating Units

Appearance	Model
	ZX-CAL2

Receiver-Controller Extension Cable

Cable length	Model		Quantity
	Standard cable	Flexible cable	
1m	ZX-XGC1A	ZX-XGC1R	1
2m	ZX-XGC2A	ZX-XGC2R	
5m	ZX-XGC5A	ZX-XGC5R	
8m	ZX-XGC8A	ZX-XGC8R	
20m	ZX-XGC20A	ZX-XGC20R	

Up to two extension cables can be connected. However, be sure to limit the total extension cable length between the receiver and the Controller to 30 meters (including the receiver cable).

Specifications

Sensor

Item	ZX-GT28S11	ZX-GT2840S11	ZX-GT28S41	ZX-GT2840S41
Output type	NPN		PNP	
Appearance	Separate type	Integrated type	Separate type	Integrated type
Light source	Visible semiconductor laser diode (wavelength 650 nm, CLASS 1 of EN60825-1/IEC60825-1, CLASS II of FDA(21CFR 1040.10 and 1040.11))			
Measuring width	28mm			
Sensing distance	0 to 500mm	40mm	0 to 500mm	40mm
Minimum sensing object	0.5mm dia.(^{*1})	0.2mm dia.	0.5mm dia.(^{*1})	0.2mm dia.
Linearity	±0.1%F.S.(^{*2})			
Resolution	10μm(number of process values to average: 16)(^{*3})			
Temperature characteristic	±0.01%F.S/C(^{*4})			
Indicators (emitter)	Laser ON indicator (green), laser alarm indicator (red)			
Indicator (receiver)	Optical axis setting indicator (green)			
Laser OFF input/sync input	ON: Short-circuited with 0 V or 1.5 V max. OFF:Open (leakage current: 0.1 mA max.)		ON: Short-circuited with power supply voltage or power supply voltage -1.5 V max. OFF:Open (leakage current: 0.1 mA max.)	
Laser deterioration alarm output	NPN open-collector output 30 VDC 20 mA max. Residual voltage 1.2 V max.		PNP open-collector output 30 VDC 20 mA max. Residual voltage 2 V max.	
Power consumption (emitter)	30 mA max.			
Power supply voltage (emitter)	24 VDC +10%, -15% ripple (p-p) 10% max.			
Dielectric strength	1,000 VAC, 50/60 Hz for 1 min			
Insulation resistance	20 MΩ (at 500 VDC megger)			
Operating ambient illumination (emitter)	3000 lx (incandescent light)			
Operating ambient illumination (receiver)	1000 lx (incandescent light)(^{*5})			
Ambient temperature	Operating: 0 to +40°C Storage: -15 to +50°C(with no icing or condensation)			
Ambient humidity	Operating and storage: 35 to 85% (with no condensation)			
Vibration resistance (durability)	10 to 150 Hz Single-amplitude: 0.75 mm for 80 min each in X, Y and Z directions			
Degree of protection	IEC60529 IP40			
Cable length	2m			
Material	Case: aluminum die-cast, Lens: glass			
Weight (packed state)	Approx.550g	Approx.570g	Approx.550g	Approx.570g
Accessories	Laser warning labels, Instruction Sheet			

F.S.: 28 mm measuring range of receiver

^{*1}: Distance between emitter and receiver: 500 mm, measurement object at 250 mm from receiver.

Glass ends of chamfer 0.1 mm or more can be detected in glass edge measurement mode. (at binary level 70%)

^{*2}: Linearity is given to be a typical error with respect to an ideal straight line when the distance between the emitter and receiver is 100 mm and light is blocked at a distance of 50 mm from the receiver.
(On the ZX-GT2840__, the measurement object is measured at a distance of 20 mm from the receiver.)

^{*3}: The amount of fluctuation (±3σ) in the analog output when the distance between the emitter and receiver is 100 mm and a ZX-GTC__ is connected

^{*4}: Change in the light cutoff value on one side when the distance between the emitter and receiver is 100 mm and the light is half-cutoff at a distance of 50 mm from the receiver
(On the ZX-GT2840__, the measurement object is measured at a distance of 20 mm from the receiver.)

^{*5}:Standard mode(NORM) used

Specifications

Controller

Item	ZX-GTC11	ZX-GTC41
Output type	NPN	PNP
Measurement cycle(*1)	1.5ms(standard mode(NORM)) 0.5ms(high-speed mode(FAST)) (*2)	
Samples to average	1/2/4/8/16/32/64/128/256/512/1024/2048/4096	
Analog output(*3)	For current output: 4 to 20mA/F.S., max. load resistance 300 Ω For voltage output: ±4V, (±5 V, 1 to 5 V (*4)), output impedance 100 Ω	
Timing input, bank switching input, zero reset input, reset input	ON: short-circuited with 0V or 1.5V max. OFF: Open (leakage current: 0.1 mA max.)	ON: short-circuited with power supply voltage or power supply voltage -1.5V max. OFF: Open (leakage current: 0.1 mA max.)
HIGH/PASS/LOW Judgment output (*5) Sync output(*6)	NPN open-collector output 30 VDC 50 mA max. Residual voltage 1.2 V max.	PNP open-collector output 30 VDC 50 mA max. Residual voltage 2V max.
Indicator	Judgment output indicator: HIGH (orange), PASS (green), LOW (orange) Main display (red) Sub-display (yellow) Bank 1/2 (orange), zero reset (green)	
Main functions	Number of registered setups	2 banks
	Measurement Mode	Interrupted beam width measurement, incident beam width measurement, outer diameter measurement, center position measurement, IC lead pitch, IC lead width judgment, specified edge measurement, wire position measurement, glass edge position measurement
	Display during measurement	Measured value, resolution, threshold, voltage output value, current output value (number of display digits can be changed)
	Zero reset functions	Offset setting of zero reset value, zero reset value memory
	Hold	Sample hold, peak hold, bottom hold, peak-to-peak hold, average hold, delay hold
	Timer functions	ON delay, OFF delay, one-shot
	Adjustment functions	Optical Axis adjust mode/light intensity writing mode, variable binary level, variable edge filter, analog output scaling
	Calculation	2Possible on up to two Controllers (Calculation Unit ZX-CAL2 is required for connecting Controllers to each other.) A-B, A+B, width
Other	Measurement cycle setting, threshold setting, hysteresis setting, initialization, key lock	
Temperature characteristic	±0.005%F.S./°C	
Current consumption	150 mA max. (including receiver)	
Power supply voltage	24 VDC +10%, -15% ripple (p-p) 10% max.	
Dielectric strength	1,000 VAC, 50/60 Hz for 1 min	
Insulation resistance	20 MΩ (at 500 VDC megger)	
Ambient temperature	Operating: 0 to +50°C Storage: -15 to +60°C (with no icing or condensation)	
Ambient humidity	Operating and storage: 35 to 85% (with no condensation)	
Vibration resistance(durability)	10 to 150 Hz Single-amplitude: 0.35 mm for 80 min each in X, Y and Z directions	
Degree of protection	IEC60529 IP20	
Cable length	2m	
Material	Case: PBT (polybutylene terephthalate), Cover: Polycarbonate	
Weight (packed state)	Approx.330g	
Accessories	Instruction Sheet	

*1: The first response time is "measurement cycle x (number of samples to average setting + 1) + 1 ms" max. For the second response time onwards, the specified measurement cycle time is output.

*2: The response time in the high-speed mode (FAST) for the IC lead pitch and IC lead width judgment modes is 1 ms.

*3: Current/voltage can be switched using the switch provided on the rear of the Controller.

*4: Can be set by the analog output scaling function.

*5: The error (ERR) state is displayed when all HIGH/PASS/LOW outputs turn OFF.

*6: Normally, wire the sync output wire directly to the emitter's sync input wire and run the Controller in the standard mode. On an NPN type Controller, use an NPN type emitter, and on a PNP type Controller, use a PNP type emitter. Wiring of the sync wires is not required when the Controller is run in the high-speed mode. (Note, however, that the Controller becomes more susceptible to the influence of ambient light in this case.)

Interface Unit

Item	ZX-GIF11/-GIF11A	ZX-GIF41/-GIF41A
Compatible Controller	ZX-GTC11	ZX-GTC41
Indicator	Power ON (green), Controller communications (orange), Controller communications error (red), RS-232C communications (orange), RS-232C communications error (red), binary output (orange)	
Communications port	RS-232C (9-pin D-sub connector)	
12-bit binary output (D11 toD0, GATE)	NPN open-collector output 30 VDC 20mA max. Residual voltage 1.2 V max.	PNP open-collector output 30 VDC 20 mA max. Residual voltage 2 V max.
Power supply voltage	Supplied from Controller (power consumption: 60 mA max.)	
Dielectric strength	1,000 VAC, 50/60 Hz for 1 min	
Insulation resistance	20 MΩ (at 500 VDC megger)	
Ambient temperature	Operating: 0 to +50°C Storage: -15 to +60°C(with no icing or condensation)	
Ambient humidity	Operating and storage: 35 to 85% (with no condensation)	
Vibration resistance(durability)	10 to 150 Hz Single-amplitude: 0.35 mm for 80 min each in X, Y and Z directions	
Degree of protection	IEC60529 IP20	
Cable length	RS-232C 0.5 m, binary output 2 m	
Material	Case: PBT (polybutylene terephthalate), Cover: Polycarbonate	
Weight (packed state)	ZX-GIF_1A:Approx.550g ZX-GIF_1:Approx.330g	
Accessories	ZX-GIF_1A:Setup Software (CD-ROM), 2 clamps, Instruction Sheet ZX-GIF_1:2 clamps, Instruction Sheet	

External Dimensions (Unit: mm)

Sensor

Separate type: ZX-GT28S11/-GT28S41

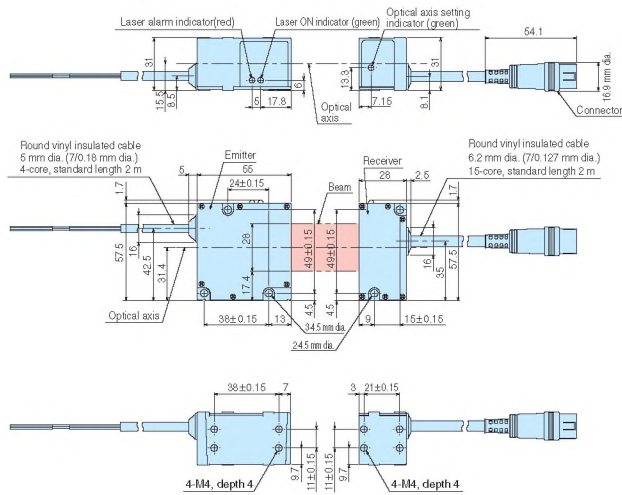

Integrated type: ZX-GT2840S11/-GT2840S41

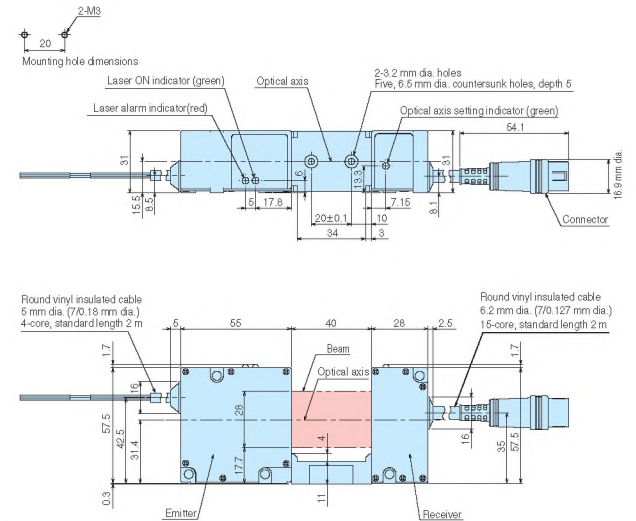

Controller

ZX-GTC11/-GTC41

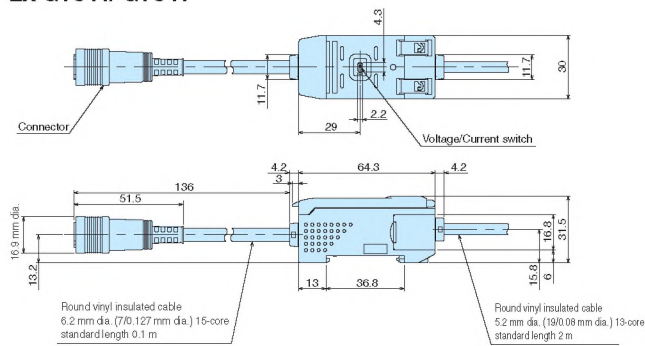

Interface Unit

ZX-GIF11/-GIF41

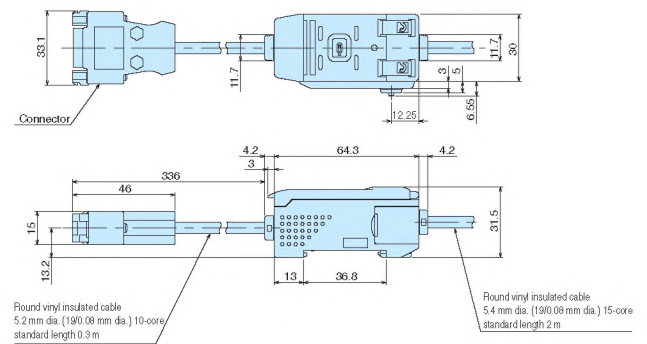

Calculating Unit

ZX-CAL2

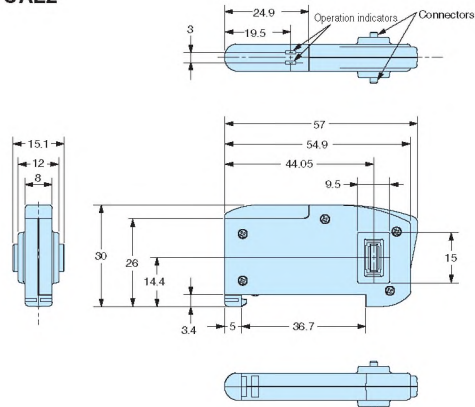

Receiver-Controller Extension Cable

ZX-XGC_A/-XGC_R

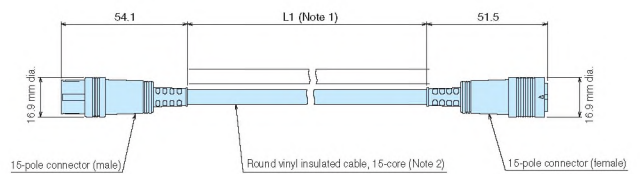

Note 1: ZX-XGC1A/R : 1M
 ZX-XGC2A/R : 2M
 ZX-XGC5A/R : 5M
 ZX-XGC8A/R : 8M
 ZX-XGC20A/R : 20M

Note 2: Standard cable: 6.2 mm dia.
 Flexible cable: 6.1 mm dia.