

Machine Automation Controller NJ/NX-series

Startup Guide for Sysmac Library Adept Robot Control Library

SYSMAC-XR009

SYSMAC-SE20□□



Startup
Guide

Terms and Restrictions

- (1) Unauthorized duplication, copying, reproduction, or modification of any part or all of this guide is strictly prohibited.
- (2) Note that the contents of this guide, such as listed specifications, are subject to change without prior notice due to improvements.
- (3) Every effort is made to ensure that the contents of this manual are without error.
Please contact our Sales Office or one of our branches if any errors or other issues are found.
Please provide the manual number found at the back of the manual when informing us of any errors in the manual.

Trademarks

- Sysmac and SYSMAC are trademarks or registered trademarks of OMRON Corporation in Japan and other countries for OMRON factory automation products.
 - Windows, Windows XP, Windows Vista, Windows 7, and Windows 8 are registered trademarks of Microsoft Corporation in the USA and other countries.
 - Intel, the Intel logo, and Intel Atom are the trademarks of Intel Corporation in the USA and other countries.
 - EtherCAT® is a registered trademark of German-based Beckhoff Automation GmbH and is a licensed, patented technology.
 - ODVA, CIP, Componet, DeviceNet, and EtherNet/IP are trademarks of ODVA.
 - The SD and SDHC logos are trademarks of SD-3C, LLC.
- Other systems and products listed in this document are trademarks or registered trademarks of their respective owners.

Introduction

The Startup Guide for Adept Robot Control Library (hereinafter, may be referred to as the Guide) describes the procedures to launch the Adept robot control library (hereinafter, may be referred to as the function blocks), which controls Robot controllers from NJ/NX-series devices when Robot controllers manufactured by Omron Adept Technologies, Inc. are used in combination with an NJ/NX-series CPU Unit.

You can perform the procedures that are presented in this Guide to quickly gain a basic understanding of the function blocks.

This Guide contains the following references regarding the procedures to wire and set operation settings for the Robot controller and the robot, and the procedures to connect and set operation settings for the NJ/NX-series CPU Unit.

Reference these and other related manuals as necessary.

Cat. No.	Manual name	Application
W513	Machine Automation Controller NJ-series Startup Guide for CPU Unit	This document provides basic programming knowledge and serves as a reference on programming and debugging.
P649	Machine Automation Controller NJ-series EtherNet/IP™ Connection Guide - OMRON Corporation Adept Robot of ePLC	This document serves as a reference on wiring the Robot controller, setting operation settings, and setting the NJ-series CPU Unit.

This Guide does not contain robot safety information and other details that are required for actual use of the robot. Thoroughly read and understand the Industrial Robot Safety Guide and manuals for all devices in your environment, to ensure that the system is used safely. Review the entire contents of these materials, including all safety precautions, precautions for safe use, and Special Restriction.

Intended Audience

This Guide is intended for the following personnel, who must also have knowledge of electrical systems (an electrical engineer or the equivalent), industrial robots, the NJ/NX-series CPU Unit, and Sysmac Studio.

- Personnel in charge of introducing FA systems.
- Personnel in charge of designing FA systems.

Applicable Products

This Guide covers the following products.

- CPU Units of NJ/NX-series Machine Automation Controllers
- Sysmac Studio Automation Software
- SmartController EX, eAIB, and eMB Robot controllers
- Hornet series, Viper series, and Cobra series robots
- Automation Control Environment (ACE)

Terms and Conditions Agreement

Robot System Products and Machine Automation Controller NJ/NX-series CPU Units

Warranty, Limitations of Liability

- **Warranties**

Exclusive Warranty

Omron's exclusive warranty is that the Products will be free from defects in materials and workmanship for a period of twelve months from the date of sale by Omron (or such other period expressed in writing by Omron). Omron disclaims all other warranties, express or implied.

Limitations

OMRON MAKES NO WARRANTY OR REPRESENTATION, EXPRESS OR IMPLIED, ABOUT NON-INFRINGEMENT, MERCHANTABILITY OR FITNESS FOR A PARTICULAR PURPOSE OF THE PRODUCTS. BUYER ACKNOWLEDGES THAT IT ALONE HAS DETERMINED THAT THE PRODUCTS WILL SUITABLY MEET THE REQUIREMENTS OF THEIR INTENDED USE.

Omron further disclaims all warranties and responsibility of any type for claims or expenses based on infringement by the Products or otherwise of any intellectual property right.

Buyer Remedy

Omron's sole obligation hereunder shall be, at Omron's election, to (i) replace (in the form originally shipped with Buyer responsible for labor charges for removal or replacement thereof) the non-complying Product, (ii) repair the non-complying Product, or (iii) repay or credit Buyer an amount equal to the purchase price of the non-complying Product; provided that in no event shall Omron be responsible for warranty, repair, indemnity or any other claims or expenses regarding the Products unless Omron's analysis confirms that the Products were properly handled, stored, installed and maintained and not subject to contamination, abuse, misuse or inappropriate modification. Return of any Products by Buyer must be approved in writing by Omron before shipment. Omron Companies shall not be liable for the suitability or unsuitability or the results from the use of Products in combination with any electrical or electronic components, circuits, system assemblies or any other materials or substances or environments. Any advice, recommendations or information given orally or in writing, are not to be construed as an amendment or addition to the above warranty.

See <http://www.omron.com/global/> or contact your Omron representative for published information.

- **Limitation on Liability; Etc**

OMRON COMPANIES SHALL NOT BE LIABLE FOR SPECIAL, INDIRECT, INCIDENTAL, OR CONSEQUENTIAL DAMAGES, LOSS OF PROFITS OR PRODUCTION OR COMMERCIAL LOSS IN ANY WAY CONNECTED WITH THE PRODUCTS, WHETHER SUCH CLAIM IS BASED IN CONTRACT, WARRANTY, NEGLIGENCE OR STRICT LIABILITY.

Further, in no event shall liability of Omron Companies exceed the individual price of the Product on which liability is asserted.

Application Considerations

- **Suitability of Use**

Omron Companies shall not be responsible for conformity with any standards, codes or regulations which apply to the combination of the Product in the Buyer's application or use of the Product. At Buyer's request, Omron will provide applicable third party certification documents identifying ratings and limitations of use which apply to the Product. This information by itself is not sufficient for a complete determination of the suitability of the Product in combination with the end product, machine, system, or other application or use. Buyer shall be solely responsible for determining appropriateness of the particular Product with respect to Buyer's application, product or system. Buyer shall take application responsibility in all cases.

NEVER USE THE PRODUCT FOR AN APPLICATION INVOLVING SERIOUS RISK TO LIFE OR PROPERTY WITHOUT ENSURING THAT THE SYSTEM AS A WHOLE HAS BEEN DESIGNED TO ADDRESS THE RISKS, AND THAT THE OMRON PRODUCT(S) IS PROPERLY RATED AND INSTALLED FOR THE INTENDED USE WITHIN THE OVERALL EQUIPMENT OR SYSTEM.

Programmable Products

Omron Companies shall not be responsible for the user's programming of a programmable Product, or any consequence thereof.

Disclaimers

- **Performance Data**

Data presented in Omron Company websites, catalogs and other materials is provided as a guide for the user in determining suitability and does not constitute a warranty. It may represent the result of Omron's test conditions, and the user must correlate it to actual application requirements. Actual performance is subject to the Omron's Warranty and Limitations of Liability.

- **Change in Specifications**

Product specifications and accessories may be changed at any time based on improvements and other reasons. It is our practice to change part numbers when published ratings or features are changed, or when significant construction changes are made. However, some specifications of the Product may be changed without any notice. When in doubt, special part numbers may be assigned to fix or establish key specifications for your application. Please consult with your Omron's representative at any time to confirm actual specifications of purchased Product.

- **Errors and Omissions**

Information presented by Omron Companies has been checked and is believed to be accurate; however, no responsibility is assumed for clerical, typographical or proofreading errors or omissions.

Robot System Products

Even if it conforms to all instructions in this safety guide, it isn't possible to guarantee that a robot system will be free from an accident resulting in injury or death or considerable damage to property caused by the industrial robot. It is the customer's responsibility to implement appropriate security measures based on their own risk assessment.

WARRANTY

- The warranty period for the Software is one year from the date of purchase, unless otherwise specifically agreed.
- If the User discovers defect of the Software (substantial non-conformity with the manual), and return it to OMRON within the above warranty period, OMRON will replace the Software without charge by offering media or download from OMRON's website. And if the User discovers defect of media which is attributable to OMRON and return it to OMRON within the above warranty period, OMRON will replace defective media without charge. If OMRON is unable to replace defective media or correct the Software, the liability of OMRON and the User's remedy shall be limited to the refund of the license fee paid to OMRON for the Software.

LIMITATION OF LIABILITY

- THE ABOVE WARRANTY SHALL CONSTITUTE THE USER'S SOLE AND EXCLUSIVE REMEDIES AGAINST OMRON AND THERE ARE NO OTHER WARRANTIES, EXPRESSED OR IMPLIED, INCLUDING BUT NOT LIMITED TO, WARRANTY OF MERCHANTABILITY OR FITNESS FOR PARTICULAR PURPOSE. IN NO EVENT, OMRON WILL BE LIABLE FOR ANY LOST PROFITS OR OTHER INDIRECT, INCIDENTAL, SPECIAL OR CONSEQUENTIAL DAMAGES ARISING OUT OF USE OF THE SOFTWARE.
- OMRON SHALL HAVE NO LIABILITY FOR DEFECT OF THE SOFTWARE BASED ON MODIFICATION OR ALTERNATION TO THE SOFTWARE BY THE USER OR ANY THIRD PARTY.
- OMRON SHALL HAVE NO LIABILITY FOR SOFTWARE DEVELOPED BY THE USER OR ANY THIRD PARTY BASED ON THE SOFTWARE OR ANY CONSEQUENCE THEREOF.

APPLICABLE CONDITIONS

USER SHALL NOT USE THE SOFTWARE FOR THE PURPOSE THAT IS NOT PROVIDED IN THE ATTACHED USER MANUAL.

CHANGE IN SPECIFICATION

The software specifications and accessories may be changed at any time based on improvements and other reasons.

ERRORS AND OMISSIONS

The information in this manual has been carefully checked and is believed to be accurate; however, no responsibility is assumed for clerical, typographical, or proofreading errors, or omissions.

Precautions

- When building a system, check the specifications for all devices and equipment that will make up the system and make sure that the OMRON products are used well within their rated specifications and performances.
Safety measures, such as safety circuits, must be implemented in order to minimize the risks in the event of a malfunction.
- Thoroughly read and understand the manuals for all devices and equipment that will make up the system to ensure that the system is used safely.
Review the entire contents of these materials, including the Industrial Robot Safety Guide, all safety precautions, and precautions for safe use.
- Confirm all regulations, standards, and restrictions that the system must adhere to.
- Unauthorized duplication, copying, reproduction, or modification of any part or all of this document without written permission from Omron Corporation is strictly prohibited.
- The content in this document is current as of April, 2016.
- The contents of this manual are subject to change without prior notice due to improvements.
- Special information in this document is classified as follows:



WARNING

Indicates a potentially hazardous situation which, if not avoided, could result in death or serious injury. Additionally, there may be severe property damage.



Caution

Indicates a potentially hazardous situation which, if not avoided, may result in minor or moderate injury, or property damage.



Precautions for Safe Use

Precautions on what to do and what not to do to ensure safe usage of the product.



Precautions for Correct Use

Precautions on what to do and what not to do to ensure proper operation and performance.



Additional Information

Additional information to read as required.

This information is provided to increase understanding or make operation easier.

Symbols



The triangle symbol indicates cautions (including warnings).
The specific operation is shown in the triangle and explained in text.
This example indicates a caution for electric shock.



The filled circle symbol indicates operations that you must do.
The specific operation is shown in the circle and explained in text.
This example indicates a general precaution.

Related Manuals

Thoroughly read and understand the manuals for all of the devices and equipment that comprise the system to ensure that the system is used safely. Review the entire contents of these materials, including all safety precautions and precautions for safe use.

Cat. No.	Models	Manual name
W500	NJ501-□□□□ NJ301-□□□□ NJ101-□□□□	NJ-series CPU Unit Hardware User's Manual
W535	NX701-1□□□ NX-PA9001/PD7001	NX-series CPU Unit Hardware User's Manual
W501	NJ501-□□□□ NJ301-□□□□ NJ101-□□□□	NJ/NX-series CPU Unit Software User's Manual
W505	NJ501-□□□□ NJ301-□□□□ NJ101-□□□□	NJ/NX-series CPU Unit Built-in EtherNet/IPTM Port User's Manual
W504	SYSMAC-SE2□□□	Sysmac Studio Version 1 Operation Manual
0969584-7	W4S1-05□ W4S1-03B	Industrial Ethernet Switch W4S1-series User's Manual
W575	-	Machine Automation Controller NJ-series Sysmac Library User's Manual for Adept Robot Control Library
P649	-	Machine Automation Controller NJ-series EtherNet/IP Connection Guide OMRON Corporation Adept Robot of ePLC
I590	-	Robot Safety Guide
I591	Cobra350	Cobra 350 Robot User's Guide
I592	Cobra350	Cobra 350 Robot ePLC Quick Setup Guide
I593	eCobra 600/800/800 Inverted	eCobra 600, 800, and 800 Inverted Robots User's Guide
I594	eCobra 600/800/800 Inverted	eCobra 600, 800, and 800 Inverted Robots ePLC Quick Setup Guide
I595	Hornet 565	Hornet 565 Robot Quick Setup Guide
I596	Hornet 565	Hornet 565 Robot User's Guide
I597	Quattro 650H/650HS/800H/800HS	Quattro 650H/650HS/800H/800HS User's Guide
I598	Quattro 650H/650HS/800H/800HS	Quattro 650H/650HS/800H/800HS ePLC Quick Setup Guide
I599	Viper 650/850 eMB-60R	Viper 650/850 Robot with eMB-60R User's Guide
I600	Viper 650/850	Viper 650/850 ePLC Quick Setup Guide
I601	T20	T20 Pendant User's Guide
I602	SmartController EX	SmartController EX User's Guide
I603	ACE	ACE User's Guide
I604	-	eV+ Language User's Guide
I605	-	eV+ Language Reference Guide
I606	-	eV+ Operating System User's Guide
I607	-	eV+ Operating System Reference Guide
I608	SmartVision MX	SmartVision MX User's Guide
I609	ACE Sight	ACE Sight Reference Guide

Revision History

A manual revision code appears as a suffix to the catalog number on the front and back covers of the manual.

Cat. No.	P103-E1-01
-----------------	-------------------

↑
Revision code

Revision code	Date	Revised content
01	April 2016	Original production

CONTENTS

Introduction	2
Intended Audience	2
Applicable Products	3
Terms and Conditions Agreement	4
Robot System Products and Machine Automation Controller NJ/NX-series CPU Units ..	4
Warranty, Limitations of Liability	4
Application Considerations	5
Disclaimers	5
Robot System Products	6
Automation Software Sysmac Studio	7
WARRANTY	7
LIMITATION OF LIABILITY	7
APPLICABLE CONDITIONS	7
CHANGE IN SPECIFICATION	7
ERRORS AND OMISSIONS	7
Precautions	8
Related Manuals	10
Revision History	11
1. System Configuration	14
1.1. System Configuration and Configuration Devices	14
1.2. Robot System	16
1.3. Function block list	17
2. Before You Begin	18
2.1. Downloading the Sysmac Library	18
2.2. Installing the Sysmac Library	23
2.3. Importing the Sysmac Library into Sysmac Studio	26
3. EtherNet/IP Settings	29
3.1. Communication Settings	29
Communication Settings of Personal Computer	29
EtherNet/IP Communication Settings	29
3.2. Global Variables	30
3.3. Tag Sets	31
3.4. Tag Data Link Tables	31
4. EtherNet/IP Connections	33
4.1. Procedural Sequence	33
4.2. Robot Controller Settings	35
Cable Connections	35
IP Address Settings	35
4.3. Controller Setup	36
IP Address Settings	36
Target Device Registration	36
Registering Global Variables	36
Tag Registration	36
Setting Connections	36
Transferring Project Data	37

4.4. Confirming EtherNet/IP Communication	38
Connection Status Confirmation	38
Data Exchange Confirmation	38
5. Programming	39
5.1 Programming Overview	39
Program name	40
Global variables	40
Internal and External Variables	41
Sample Programs	43
5.2. Creating Sample Programs	47
Adding Programs	47
Creating Global Variables	50
Registering Internal and External Variables	52
Writing Programs	55
Setting Tasks to Global Variables	57
Set Tasks to Programs	59
5.3. Debugging Programs	61
Transferring Programs	61
Debugging Programs	61
6. Appendix - Initialization Method	69
6.1. Initializing Controllers	69

1. System Configuration

1.1. System Configuration and Configuration Devices

This section describes the system configuration and devices used in this Guide.

The following figure illustrates the system configuration.

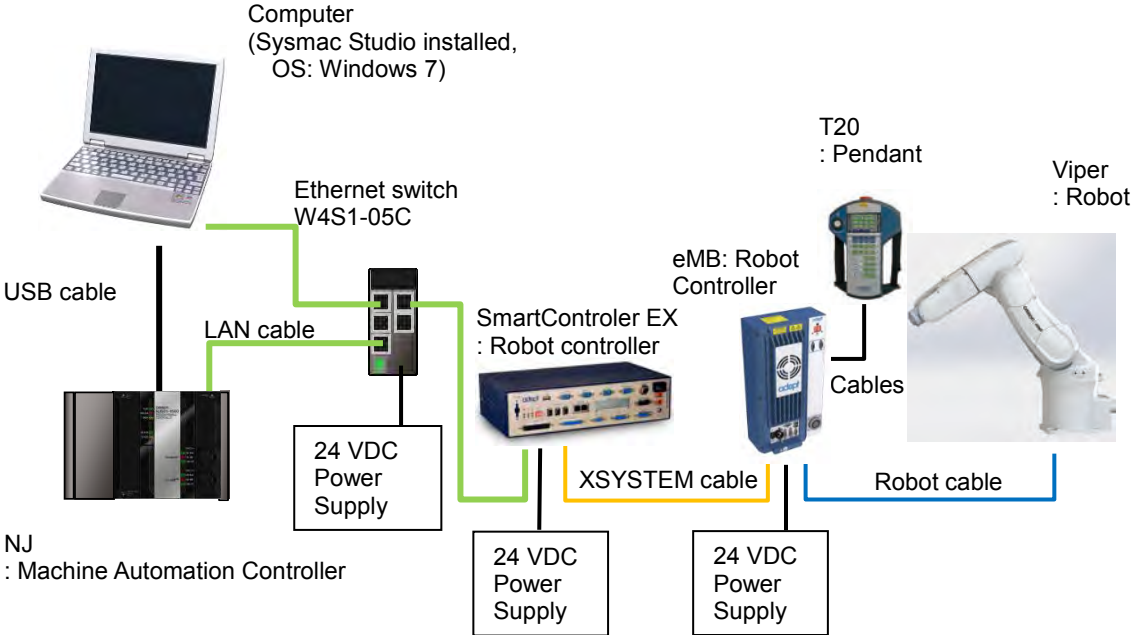

The following table shows the functions and software versions described in this Guide.
When you select devices for an actual application, refer to the device manuals.

Device name	Model numbers	Version
NJ-series CPU Unit (Built-in EtherNet/IP port)	NJ501-1500	Ver.1.11
Power Supply Unit	NJ-PA3001	-
Ethernet Switch	W4S1-05C	Ver.1.0
Ethernet Switch 24 VDC Power Supply	-	-
Sysmac Studio	SYSMAC-SE2□□□	Ver.1.15
IP Address Configuration Tool	(bundled with Sysmac Studio)	Ver.1.00
Personal Computer (OS: Windows 7)	-	-
USB cable ^{*1} (USB 2.0 compliant with B connector)	-	-
LAN Cable (shielded twisted pair (STP) Ethernet Category 5 or higher)	-	-
Robot	Viper 650	-
Robot Controller	SmartControllerEX (eV+)	Ver.2.3.C1
Robot Controller	eMB	-
Robot Controller 24 VDC Power Supply	-	-
eAIB XSYSTEM Cable	(bundled with robot)	-
XUSR Jumper Plug	(bundled with robot)	-
T20 Adapter Cable	(bundled with robot)	-
XBELTIO Jack	(bundled with robot)	-
Teaching Pendant	T20	-

*1. Use a USB 2.0 (or 1.1) cable with an A-B connector and maximum length of 5.0 m.

1.2. Robot System

In this Guide, a system will be configured to operate point-to-point connections using the Viper 650 vertically articulated robot. This Guide describes the procedures to set NJ Controller variable settings, EtherNet/IP connections, create programs using function blocks, and commission function blocks through program debugging and confirmation of robot operation.

As illustrated in the following figure, the system configured in this Guide operates using point-to-point connections.

(1) Confirming operation

Operation starts at the current position transitioning to target position 1 and then transitioning to target position 2.

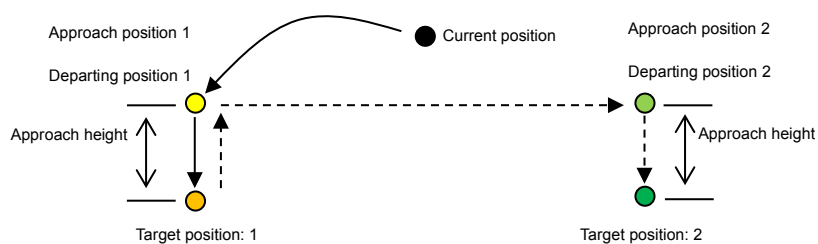

(2) Robot motion positions

Position	X	Y	Z	RX	RY	RZ
Current position	450	0	250	-180	180	-180
Target position: 1	450	100	150	-180	180	-180
Target position: 2	450	-100	150	-180	180	-180

(3) Motion control parameters (settings related to motion velocity)

Parameter	Setting
Target velocity	20
Target acceleration	100
Target deceleration	100
Maximum Velocity	100

(4) Move configuration (settings related to motion)

Parameter	Setting
Motion at approach height	Offset position
Approach height	50

1.3. Function block list

Sysmac Library: The following function blocks are provided via the Setup_EIP_Adept_V1_0_0.exe file.

Refer to 2.1. *Downloading the Sysmac Library* for information on how to obtain these function blocks.

No.	This Guide	Function Block Name	Description
1	Used	ARB_RobotControl	Used to set main robot settings and monitor robot status.
2	Not used	ARB_ReadLatch	Used to output the current robot position as latch input for an external trigger signal.
3	Used	ARB_ResetRobotError	Used to clear errors that occur in the robot.
4	Not used	ARB_Jog	Used to operate the specified robot joint or axis.
5	Not used	ARB_AlignToolCommand*	Used to rotate and align the robot tool to world coordinates.
6	Not used	ARB_MoveCommand*	Used to move the robot to the target position via linear movement or PTP movement.
7	Used	ARB_PickAndPlaceCommand*	Used to move the robot to the target position via gate operation.
8	Not used	ARB_DefineLocation	Used to set position data into the robot.
9	Not used	ARB_DefinePallet	Used to set palette information into the robot.
10	Not used	ARB_SetToolTransform	Used to set the robot with tool coordinate system conversions.
11	Not used	ARB_ResetToolTransform	Used to delete tool coordinate system set to the robot.
12	Not used	ARB_InputOutputSignals	Used to communicate with the robot via digital signal input and output.
13	Not used	ARB_TeachPendantControl	Used to send and receive information of the teaching pendant connected to the robot.
14	Not used	ARB_TeachPosition	Used to teach the subtraction positions and configuration to the robot.

2. Before You Begin

2.1. Downloading the Sysmac Library

Use the following procedure to download the Sysmac Library.



Additional Information

Refer to the *Sysmac Studio Version 1 Operation Manual* (Cat. No. W504) for information on installing the Sysmac Studio.

Use the following procedure to download the Sysmac Library.

- 1 Access the Sysmac Library Products page via the following URL.
<http://www.ia.omron.com/products/family/3459/>

OMRON Industrial Automation | Global

Home Our Strengths **Products** Technical Support Global Network About Us

Home > Products > Product Category > Automation Systems > Machine Automation Controllers > Software > SYSMAC-XR

Product Category

- Automation Systems
 - Machine Automation Controllers
 - Software
 - SYSMAC-SE2
 - SYSMAC-XR**

Product Category

- Cautions
- Item A to Z Index
- Applications
- Correction Notice

Sysmac Library

SYSMAC-XR

The Sysmac Library for the NJ/NX Machine Automation Controller provides Function Blocks packed with know-how that makes advanced control easy.

[Item list of SYSMAC-XR](#)

Sysmac Library

DOWNLOAD

Sysmac Library downloads

You can download the Sysmac Library for the NJ/NX Machine Automation Controller that provides Function Blocks. Note: For Vibration Suppression Control Library and Temperature Control Library, please ask your OMRON sales representative.

about this Product Family

[Inquiry of this Product](#)

Related Contents

- Common (4)
- Automation Systems (1)
- Machine Automation Controllers (2)
- Special Contents (1)

Features Lineup Specifications Dimensions Catalog

- 2 Click on the **Sysmac Library Download** icon to transition to the download screen.



Sysmac Library downloads

You can download the Sysmac Library for the NJ/NX Machine Automation Controller that provides Function Blocks. Note: For Vibration Suppression Control Library and Temperature Control Library, please ask your OMRON sales representative.

3 The download screen appears.

Sysmac Library downloads

You can download the Sysmac Library for the NJ/NX Machine Automation Controller that provides Function Blocks.

Precautions

- When building a system, check the specifications for all devices and equipment that will make up the system and make sure that the Omron products are used well within their rated specifications and performances. Safety measures, such as safety circuits, must be implemented in order to minimize the risks in the event of a malfunction.
- Thoroughly read and understand the manuals for all devices and equipment that will make up the system to ensure that the system is used safely. Review the entire contents of these manuals, including all safety precautions, precautions for safe use, and precautions for correct use.
- Confirm all regulations, standards, and restrictions that the system must adhere to.
- Check the user program for proper execution before you use it for actual operation.

4 Accept the Software License Agreement and transition to the login screen by clicking the **Agree the terms and move to Login Screen** button.

IMPORTANT

By downloading the software from this website, you agree to the terms of the Software License Agreement.

Software License Agreement

This Software License Agreement("Agreement") is a binding agreement between you("User") and OMRON Corporation("OMRON") on the terms and conditions of the license of this Software.

1. The term "Software" used in this Agreement means the computer programs and related documentations identified below. All title, ownership rights and intellectual property rights in and to this Software and any copies thereof remain the sole property of OMRON or its third party suppliers and shall not be assigned to the User under this Agreement. This Software: Sysmac Library
2. OMRON grants the User a non-exclusive and limited license to use this Software on one computer owned by the User for free of charge.
3. The User may not sub-license, assign, rent nor lease this Software to any third party without prior written consent of OMRON.
4. The User may not make copies of this Software except for backup. The User may also not decompile, reverse assemble and reverse engineer this Software, and take any similar action.

[Agree the terms and move to Login Screen](#)

5 Enter your Country/Region, E-mail address and License number of Sysmac Studio and then click **Next** to transition to the Sysmac Library Download Service.

Sysmac Library Download Service

Enter your e-mail address which you wrote in the member registration, region, and license No. described on the Member Registration Sheet.

Country/Region

E-mail address

License number of Sysmac Studio

[Next](#) [Reset](#)

Be sure to read the following terms first.

- (1) The license No. of this service is described on the license sheet of Sysmac Studio.
- (2) If you have not made member registration yet, please "[Click Here](#)" to make registration.

[Close](#)

© Copyright OMRON Corporation 1996-2016. All Rights Reserved.

- 6 From the Sysmac Library Download Service, right-click the Setup_EIP_Adept_V1_0_0.exe (11.6 MB) file under the Robot Control Library (SYSMAC-XR009) and select **Save target as**

Sysmac Library Download Service

Sysmac Library for NJ/NX Machine Automation Controller

The Sysmac Library for the NJ/NX Machine Automation Controller provides Function Blocks packed with know-how that makes advanced control easy.

Click [here](#) for the procedure to install Sysmac Libraries.

Adept Robot Control Library (SYSMAC-XR009)

The Adept Robot Control Library is used to directly control Adept Robots from NJ/NX-series Controller. You can use this library to control any types of robots like parallel, SCARA and articulated from NJ/NX-series Controller with common instructions and a common programming method.

Updated date	File name (File size)	Version
Apr. 11th, 2016 Initial public release	Setup_EIP_Adept_V1_0_0.exe (11.6MB)	Ver.1.0.0

- Open
- Open in new tab
- Open in new window
- Save target as...**
- Print target

- 7 Select the destination to save the file and the change the filename if desired and then click the **Save** button to save the file.

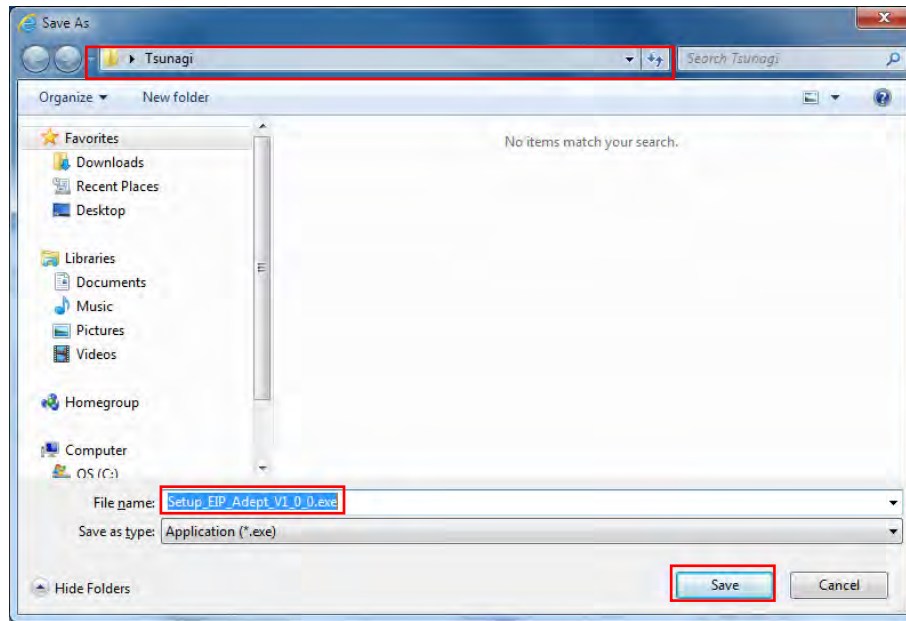

- 8 If the following screen appears, click **View downloads** to continue downloading the file.

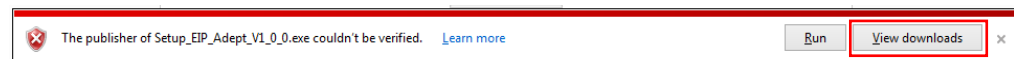

If you click **Run**, the installation of step 2 of 2.2 *Installing the Sysmac Library* starts.

9 Check the download in the View Downloads dialog box and click **Close**.

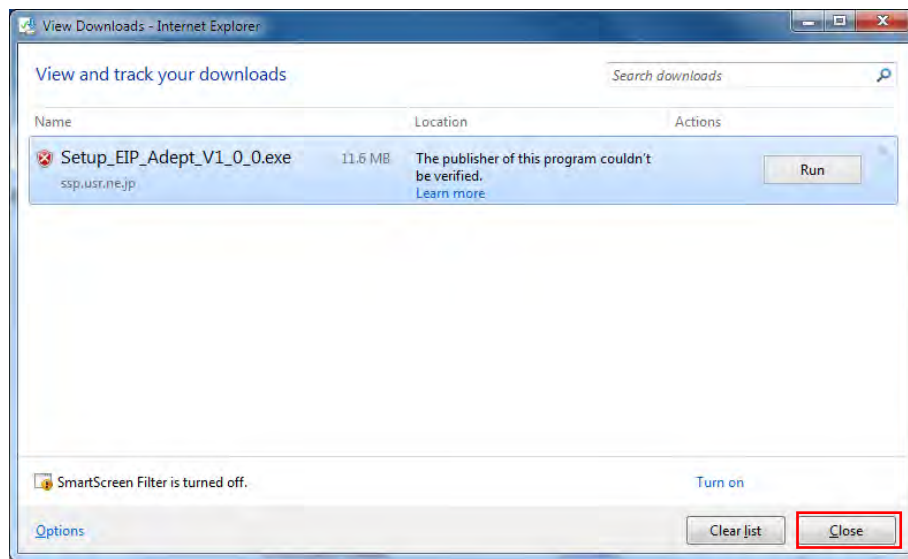

You can check that the file has been saved in the selected location.

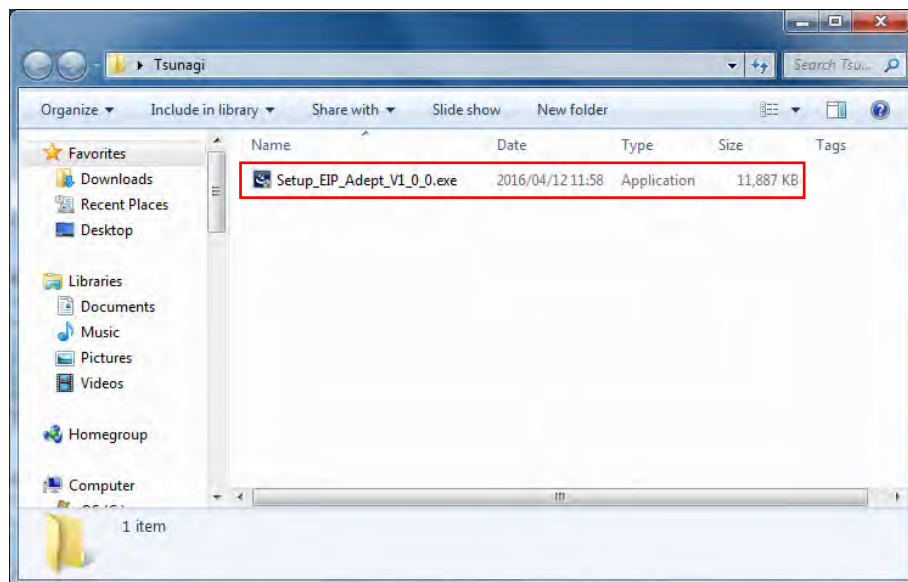

2.2. Installing the Sysmac Library

Use the following procedure to install the downloaded Sysmac Library.

- 1 Double-click the downloaded Sysmac Library file to install.

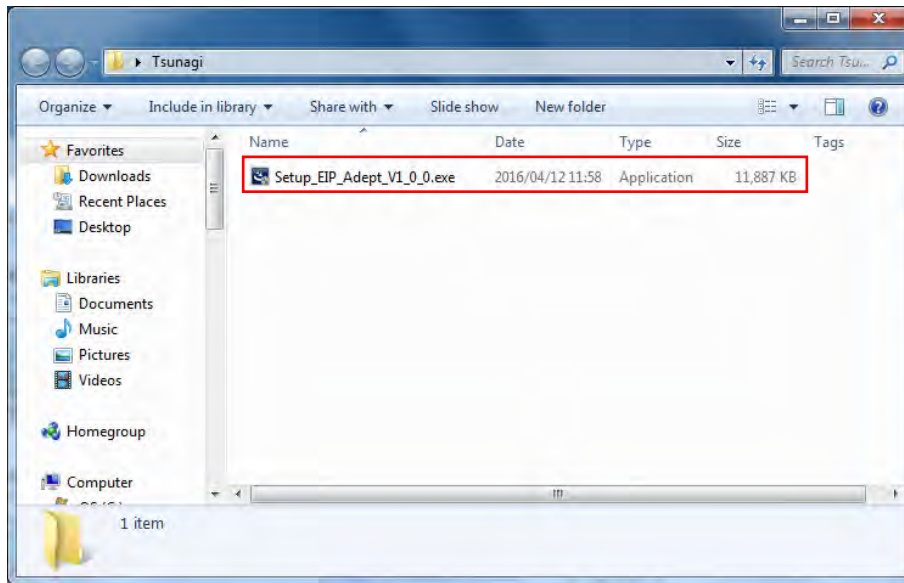

- 2 Select the desired installation language and then click **OK** to start the installation.

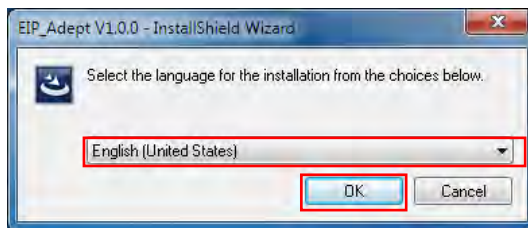

- 3 The **Preparing to Install...** dialog box appears.

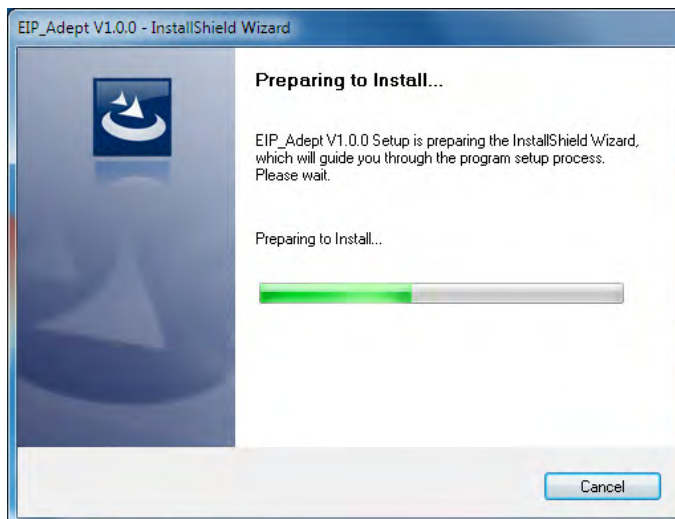

4 Click **Next** to continue with the installation.

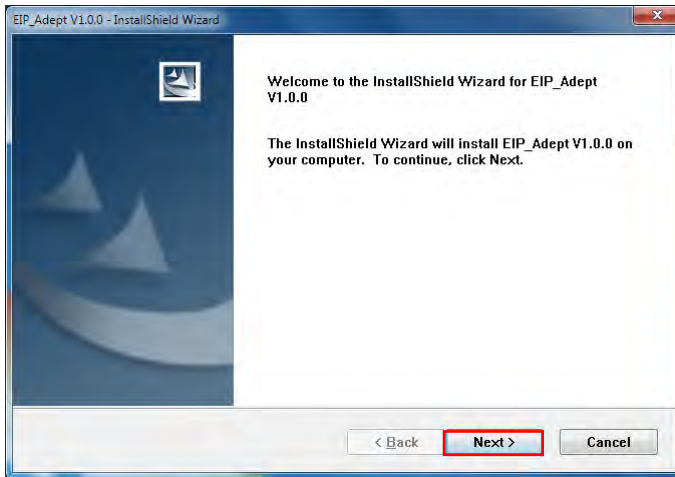

5 Accept the License Agreement and click **Next** to continue.

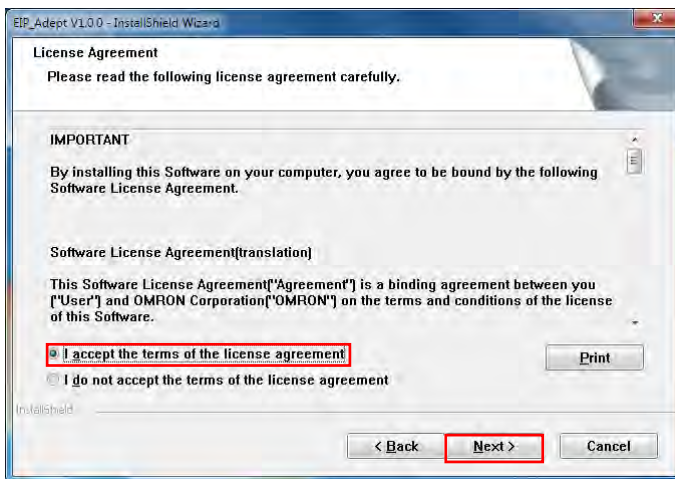

6 Select the location to install the files and click **Next** to continue.

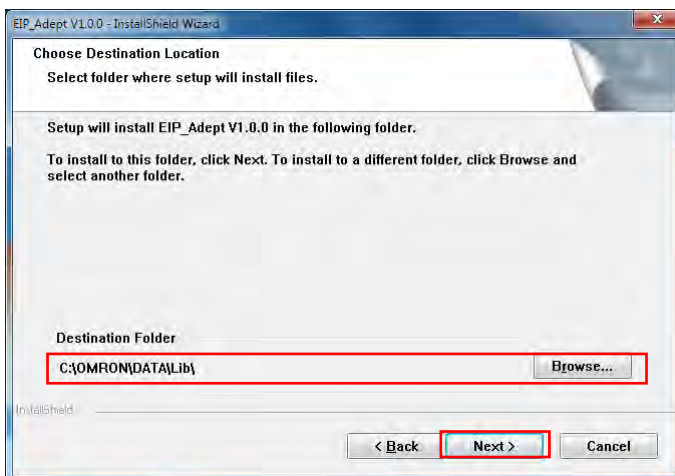

7 Click **Install** to start the installation with this configuration.

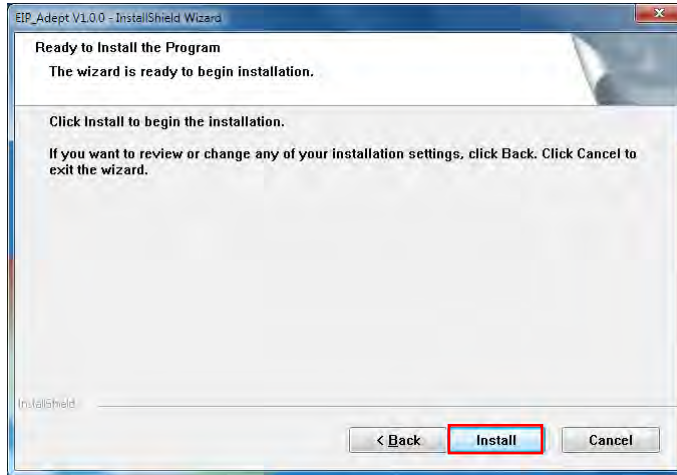

8 The **Installing** dialog box appears.

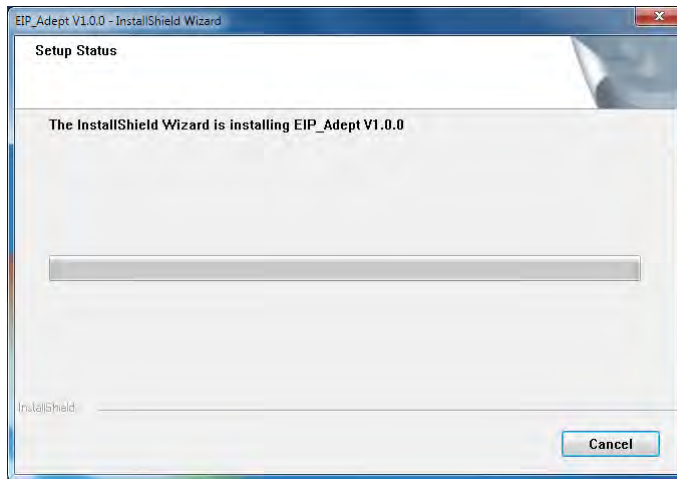

9 This dialog box indicates that the installation is complete. Click **Finish** to finish the installation process.

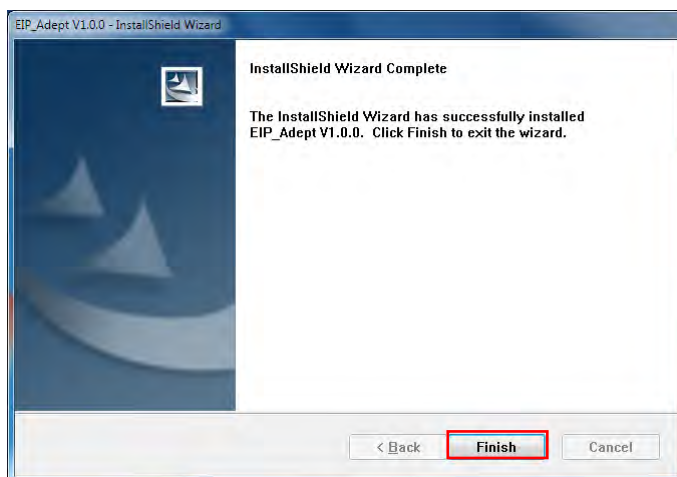

2.3.Importing the Sysmac Library into Sysmac Studio

Use the following procedure to import the installed Sysmac Library into the Sysmac Studio.

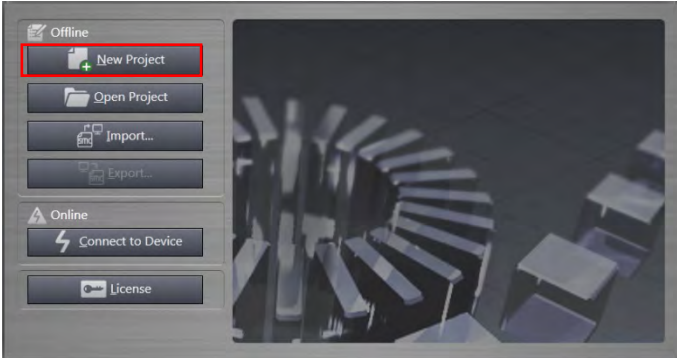
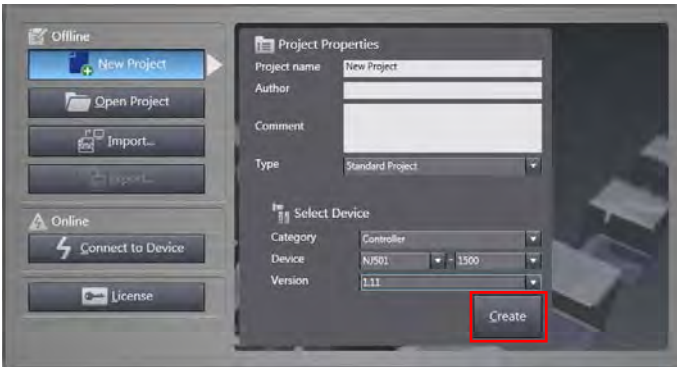
1	<p>Double-click the Sysmac Studio icon to start the Sysmac Studio.</p> <p>Note: Refer to <i>1.1. System Configuration and Configuration Devices</i> for information on the recommended Sysmac Studio version and upgrade if necessary.</p> 
2	<p>Select New Project.</p> 
3	<p>Set the project properties and then click the Create button to create a project file.</p> 

4 Start the project file.

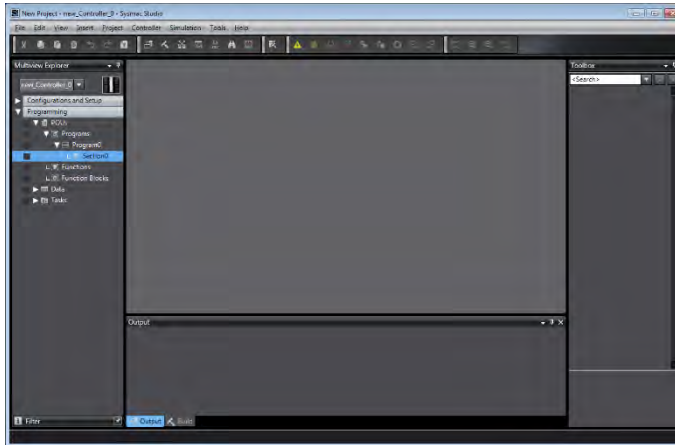

5 From the menu, select **Project, Library**, and then **Show References**.

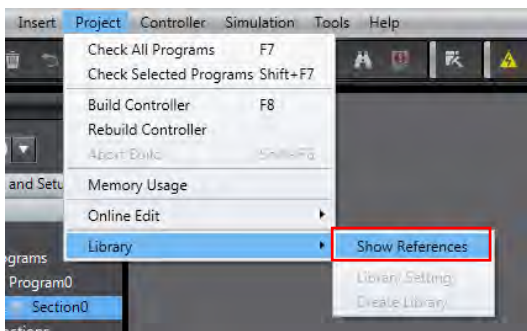

6 Select the **Include the referenced libraries when using the project** check box, click the + button, and select the reference library.

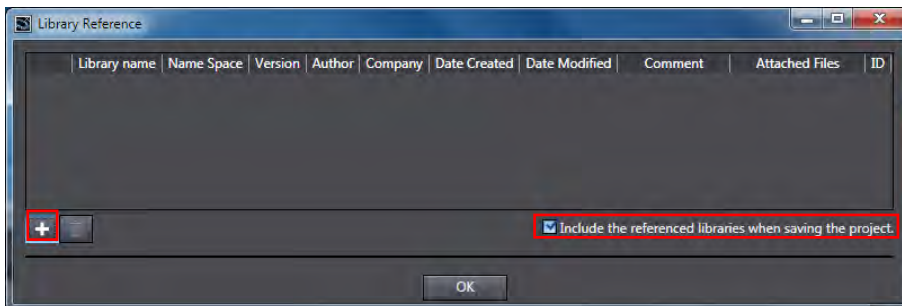

3. EtherNet/IP Settings

This section describes the setting contents of communication settings, global variables, tag sets, and tag data link that are all defined in this document.

3.1. Communication Settings

The parameters that are set in this document are shown below.

Communication Settings of Personal Computer

The parameters for Robot Controller are set on a personal computer for setting via an Ethernet network.

The following table shows the parameters required for connecting a personal computer for setting and Robot Controller using the Ethernet communications.

Setting	Personal computer for setting	Robot controller
IP address	172.16.169.10 *2	172.16.169.118 (default value) *1
Subnet mask	255.255.0.0	255.255.0.0 (default value)

*1. Each Robot Controller is allocated with a unique IP address.

Set an IP address of a personal computer for setting according to an IP address of Robot Controller.

This IP address provided above is for Robot Controller used in this document..

*2. Set an IP address of personal computer for setting, which needs to have a different host part of an IP address from the one of Robot Controller.

EtherNet/IP Communication Settings

The parameters required for connecting Controller to Robot Controller via EtherNet/IP are shown below.

Setting	Controller	Robot controller
IP address	192.168.250.1	192.168.250.2
Subnet mask	255.255.255.0	255.255.255.0

3.2. Global Variables

The following table shows details on global variables. The Controller handles tag data link data as global variables.

Name	Data type	Network publish	Robot controller allocation	Data size (bytes)
to_Robot	BYTE[214]	Output	Input area	214
from_Robot	BYTE[284]	Input	Output area	284
gRobotData	OmronLib\EIP_Adept\sARB_ROBOT_DATA_REF	Do not publish	-	-



Precautions for Correct Use

When the data size of the Robot controller tag data link has an odd number of bytes, the data types of global variables must be declared as BYTE and not BOOL.



Additional Information

The Sysmac Studio supports two types of input formats as follows to specify a variable data type as an array.

- (1) BOOL [16]
- (2) ARRAY[0..15] OF BOOL

Even if you input the data type in format (1), the Sysmac Studio automatically converts the format to format (2) so that the variable table always shows the data type in format (2).

In this Guide, this is referred to as "BOOL [16]" for simplicity.

The above example represents BOOL data type that consists a 16-element array.

3.3.Tag Sets

The following table shows the tag set settings used in the tag data link.

■ Output area (Controller to Robot controller)

Originator variable (tag set name)		Data size (bytes)
EIP002_OUT		214
OUT No.	Global variable name (tag name)	Data size (bytes)
1	to_Robot	214

■ Input area (Robot controller to Controller)

Originator variable (tag set name)		Data size (bytes)
EIP002_IN		284
IN No.	Global variable name (tag name)	Data size (bytes)
1	from_Robot	284

3.4.Tag Data Link Tables

The following table shows the settings for tag data link tables (connection settings).

The values in red-bordered cells must be the same as those in the EDS file of the Robot controller.

Connection name	Connection I/O type	RPI (ms)	Timeout Value
default_001	Robot Command/Response	50.0	RPI x 4

Connection I/O type	Input/ Output	Target Variable (Robot controller setting value: instance number)	Size (Bytes)	Originator variable (tag set name)	Size (Bytes)	Connection Type
Robot Command/Response	Input	3	214	EIP002_IN	214	Multi-cast connection
	Output	4	284	EIP002_OUT	284	Point to Point connection

■Description of Robot controller input area

Controller		Robot controller			
Global variables	Array number	Area	Name	Size	Port number
to_Robot	[0]	Robot_Command	Insturction_Command	2	-
	[2]	Input area (214 bytes)	Jog_Mode_Command	2	-
	[4]		Output_Signals_Command	2	#1641 to #1642
	[6]		Motoin_QualiFier_Command	2	-
	[8]		Motion_Parameter	20	-
	[28]		Locatoin1	24	-
	[52]		Pallet_Description	14	-
	[66]		MCP_Communication	90	-
	[156]		Location2	24	-
	[180]		Vision_Commands	8	-
	[188]		Belt_Commands	8	-
	[196]		Belt_Latch_Commands	4	-
	[200]		Belt_Description	14	-

■Description of Robot controller output area

Controller		Robot controller			
Global variables	Array number	Area	Name	Size	Port number
from_Robot	[0]	Robot_Status Output area (284 bytes)	System_State	18	#0641 to #0642
	[18]		MCP_Status	6	-
	[24]		Error_Status	92	-
	[116]		Locations	72	-
	[188]		Vision_Status	40	-
	[228]		Belt_Status	40	-
	[268]		Belt_Latch_Status	16	-

4. EtherNet/IP Connections

This section describes the procedure to connect the Robot controller and Controller via EtherNet/IP connections.

Information on some configuration procedures are in the *Machine Automation Controller NJ-series EtherNet/IP™ Connection Guide - OMRON Corporation Adept Robot of ePLC* (Cat. No. P649), and thus omitted in this guide. Please read the connection guide before performing the following procedure.

This document was created on the basis that the Controller is still at the default settings from the factory. Refer to *Appendix - Initialization Method* for information on initializing devices.

4.1. Procedural Sequence

This section describes the procedure to connect the Robot controller and the Controller via an EtherNet/IP connection and to create EtherNet/IP tag data links.

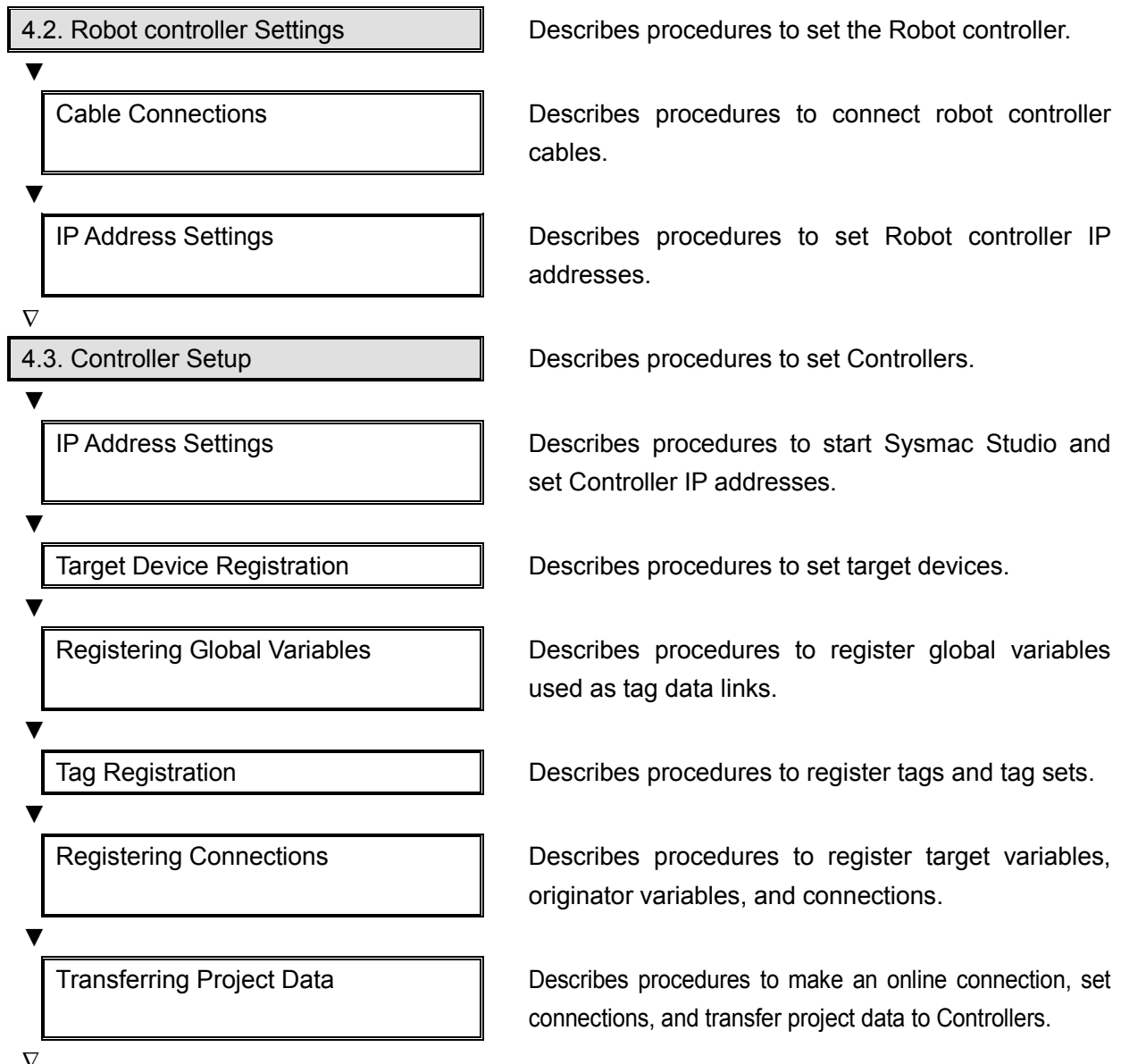

4.4. Confirming EtherNet/IP
Communication

Describes procedures to confirm that EtherNet/IP tag data links are functioning properly.

Connection Status Confirmation

Describes procedures to confirm the status of EtherNet/IP connections.

Data Exchange Confirmation

Describes procedures to confirm that data is exchanged correctly.

4.2. Robot Controller Settings

This section describes procedures to set the Robot controller.

Cable Connections

This section describes procedures to connect robot controller cables.

For more information, refer to *7.2.1 Cable Connection* in the *Machine Automation Controller NJ-series EtherNet/IP™ Connection Guide - OMRON Corporation Adept Robot of ePLC* (Cat. No. P649).

IP Address Settings

This section describes procedures to set Robot controller IP addresses.



Precautions for Correct Use

Use a personal computer and the Ethernet connection to confirm the settings of the Robot controller.

Note that the personal computer settings may need to be reconfigured.

For more information, refer to *7.2.2 IP Addresses* in the *Machine Automation Controller NJ-series EtherNet/IP™ Connection Guide - OMRON Corporation Adept Robot of ePLC* (Cat. No. P649).

4.3. Controller Setup

This section describes procedures to set Controllers.

IP Address Settings

This section describes procedures to start Sysmac Studio and set Controller IP addresses. Sysmac Studio and a USB driver must be installed beforehand.

For more information, refer to *7.3.1 IP Address Settings* in the *Machine Automation Controller NJ-series EtherNet/IP™ Connection Guide - OMRON Corporation Adept Robot of ePLC* (Cat. No. P649).

Target Device Registration

This section describes procedures to register target devices for tag data links.

For more information, refer to *7.3.2 Target Device Registration* in the *Machine Automation Controller NJ-series EtherNet/IP™ Connection Guide - OMRON Corporation Adept Robot of ePLC* (Cat. No. P649).

Registering Global Variables

This section describes procedures to register global variables used as tag data links.

For more information, refer to *7.3.3 Global Variables* in the *Machine Automation Controller NJ-series EtherNet/IP™ Connection Guide - OMRON Corporation Adept Robot of ePLC* (Cat. No. P649).

Tag Registration

This section describes procedures to register tags and tag sets used in tag data links.

For more information, refer to *7.3.4 Tag Registration* in the *Machine Automation Controller NJ-series EtherNet/IP™ Connection Guide - OMRON Corporation Adept Robot of ePLC* (Cat. No. P649).

Setting Connections

This section describes procedures to register target variables (connection establishment), originator variables (connection establishment), and connections (tag data link tables).

For more information, refer to *7.3.5 Connection Settings* in the *Machine Automation Controller NJ-series EtherNet/IP™ Connection Guide - OMRON Corporation Adept Robot of ePLC* (Cat. No. P649).

Transferring Project Data

This section describes procedures to make an online connection and transfer project data to Controllers.

WARNING

The devices or machines may operate unexpectedly regardless of the operating mode of the CPU Unit when transferring the following data from Sysmac Studio; user programs, configurations and setup data, device variables, and values in memory used for CJ-series Units.



Confirm safety at the destination slave before transferring project data.

For more information, refer to *7.3.6 Transferring Project Data* in the *Machine Automation Controller NJ-series EtherNet/IP™ Connection Guide - OMRON Corporation Adept Robot of ePLC* (Cat. No. P649).

4.4. Confirming EtherNet/IP Communication

This section describes procedures to confirm that EtherNet/IP tag data links are functioning properly.

Connection Status Confirmation

This section describes procedures to confirm the status of EtherNet/IP connections.

For more information, refer to *7.4.1 Confirming Connection Status* in the *Machine Automation Controller NJ-series EtherNet/IP™ Connection Guide - OMRON Corporation Adept Robot of ePLC* (Cat. No. P649).

Data Exchange Confirmation

This section describes procedures to confirm that data is exchanged correctly via tag data links.

For more information, refer to *7.4.2 Data Exchange Confirmation* in the *Machine Automation Controller NJ-series EtherNet/IP™ Connection Guide - OMRON Corporation Adept Robot of ePLC* (Cat. No. P649).

5. Programming

5.1 Programming Overview

This section describes the procedure to program the point-to-point connections illustrated in 1.2. Robot System.

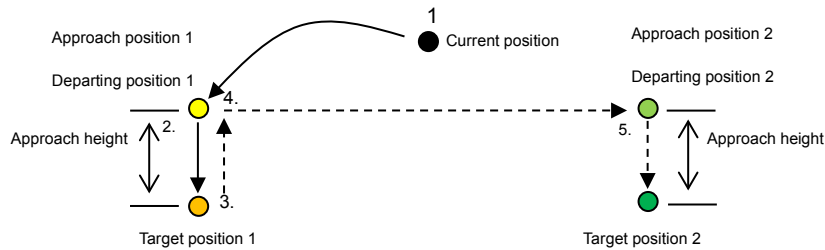

Number	Description of operation
1.	Transition from the current position to approach position 1 of target position 1.
2.	Transition from approach position 1 to target position 1.
3.	Transition from target position 1 to departing position 1.
4.	Transition from departing position 1 to approach position 2 of target position 2.
5.	Transition from approach position 2 to target position 2.

The following sections are described using the operating environment configured in Sections 2 through 4 and the resulting project file. Devices will not operate correctly if only the procedures described in this section are performed.

Caution

When function block programs are executed with an NJ-series Controller, the Robot controller and robot connected via EtherNet/IP™ operate. Perform a risk assessment and implement safety measures so that robot operation does not produce a dangerous situation.



Program name

The following table shows the names of programs used in this Guide.

Program name	Application
GetMemory	Used to create correspondence between variables used in the program and the robot control data shared with tag data links.
ResetRobotError	Used to clear errors that occur in the robot.
Exec_RobotControl	Used to execute the Enable Power instruction, Calibrate Robot instruction and Cancel Robot Movement instruction, specify settings for the Stop on input function, and monitor robot statuses, robot positions, configuration statuses and error statuses.
Exec_PickAndPlace_ToPos1	Used to move the robot to the target position 1 via gate operation.
Exec_PickAndPlace_ToPos2	Used to move the robot to the target position 2 via gate operation.

Global variables

The following table shows the names of global variables used in this Guide.

Name	Data type	Network publish
gRobotData	Omron\EIP_Adept\sARB_ROBOT_DATA_REF	Do not publish
from_Robot	ARRAY[0..283]OF BYTE	Input
to_Robot	ARRAY[0..213]OF BYTE	Output

The global variables from_Robot and to_Robot are already registered in the project file created by performing the procedures described in Sections 2 through 4 in this Guide. These do not need to be reconfigured for subsequent operations.

Internal and External Variables

The following table shows the names of internal and external variables used in this Guide.

Program name	Variable type	Name	Data type	Initial value
GetMemory	Internal Variables	-	-	-
	External Variables	to_Robot	ARRAY[0..213]OF BYTE	-
		gRobotDATA	OmronLib\EIP_Adept\sARB_ROBOT_DATA_REF	-
		from_Robot _EIP_EstbTargetSta	ARRAY[0..283]OF BYTE ARRAY[0..255]OF BOOL	- -
ResetRobot Error	Internal Variables	Enable	BOOL	FALSE
		Done	BOOL	FALSE
		Busy	BOOL	FALSE
		Error	BOOL	FALSE
		ErrorID	WORD	0000
		ErrorIDEX	DWORD	00000000
	fbResetRobotError	OmronLib\EIP_Adept\ARB_ResetRobotError	-	
External Variables	gRobotDATA	OmronLib\EIP_Adept\sARB_ROBOT_DATA_REF	-	
Exec_RobotControl	Internal Variables	enable	BOOL	FALSE
		power	BOOL	FALSE
		calibrate	BOOL	FALSE
		brake	BOOL	FALSE
		stopOnInput	BOOL	FALSE
		robotState	OmronLib\EIP_Adept\sARB_ROBOT_STATE_REF	-
		robotMotion	OmronLib\EIP_Adept\sARB_ROBOT_MOTION_REF	-
		robotPosition	OmronLib\EIP_Adept\sARB_ROBOT_POS_REF	-
		robotConfig	OmronLib\EIP_Adept\sARB_ROBOT_CONFIG_REF	-
		robotError	OmronLib\EIP_Adept\sARB_ROBOT_ERROR_REF	-
		fbRobotControl	OmronLib\EIP_Adept\ARB_RobotControl	-
		RobotControl_Enabled	BOOL	FALSE
	External Variables	gRobotData	Omronlib\EIP_Adept\sARB_ROBOT_DATA_REF	-

Exec_Pick AndPlace_ ToPos1	Internal Variables	position	Omronlib\EIP_Adept\ARB _MOVE_POSITION_REF	-
		motionParams	Omronlib\EIP_Adept\ARB _MOTION_PARAMS_REF	-
		execute	BOOL	FALSE
		blending	BOOL	FALSE
		moveConfig	Omronlib\EIP_Adept\ARB _MOVE_CONFIG_REF	-
		fbPickAndPlace	Omronlib\EIP_Adept\ARB_ PickAndPlaceCommand	-
		PickAndPlace_Enabled	BOOL	FALSE
External Variables	gRobotData	Omronlib\EIP_Adept\ARB _ROBOT_DATA_REF	-	
Exec_Pick AndPlace_ ToPos2	Internal Variables	position	Omronlib\EIP_Adept\ARB _MOVE_POSITION_REF	-
		motionParams	Omronlib\EIP_Adept\ARB _MOTION_PARAMS_REF	-
		execute	BOOL	FALSE
		blending	BOOL	FALSE
		moveConfig	Omronlib\EIP_Adept\ARB _MOVE_CONFIG_REF	-
		fbPickAndPlace	Omronlib\EIP_Adept\ARB_ PickAndPlaceCommand	-
		PickAndPlace_Enabled	BOOL	FALSE
External Variables	gRobotData	Omronlib\EIP_Adept\ARB _ROBOT_DATA_REF	-	

Sample Programs

The following shows the sample programs used in this Guide.

Refer to *Section 2 Fundamentals of Programming* in the *Machine Automation Controller NJ-series Startup Guide* (Cat. No. W513).

[GetMemory]

```
// gRobotData.StatusData is asociated with input-tag named "from_Robot".  
// gRobotData.CommandData asociated to output-tag named "to_Robot".  
// Tag information is passed to FBL by gRobotData.  
  
to_Robot := gRobotData.CommandData;  
gRobotData.StatusData := from_Robot;  
  
//gRobotData.ConnectionStatus is asociated by Normal Target Node Informaton.  
//Normal Target Node Informaton is passed to FBL by gRobotData.  
  
gRobotData.ConnectionStatus := _EIP_EstbTargetSta[2];
```

[ResetRobotError]

```
//fbResetRobotError will release the error that has occurred to the robot controller.  
  
fbResetRobotError(  
    gRobotData,  
    enable,  
    Done, Busy, Error, ErrorID, ErrorIDEX);  
  
enable:=FALSE;
```

[Exec_RobotControl]

```
//fbRobotControl controls the main robot settings and operations and monitors the Robot  
states,position,configuration and errors.
```

```
//Setting the power-on command.
```

```
IF RobotControlEnabled = TRUE THEN
```

```
    power:=TRUE;
```

```
    calibrate:=FALSE;
```

```
    brake:=FALSE;
```

```
    stopOnInput:=FALSE;
```

```
    RobotControlEnabled:=FALSE;
```

```
END_IF;
```

```
//fbRobotControl controls the main robot settings and operations and monitors the Robot  
states,position,configuration and errors.
```

```
fbRobotControl(  
    RobotData:=gRobotData,  
    Enable:=enable,  
    Power:=power,  
    Calibrate:=calibrate,  
    CancelMotion:=brake,  
    StopOnInput:=stopOnInput);
```

[Exec_PickAndPlace_ToPos1]

```
//Setting Target position, operating parameters, operating configuration.

//Depart and Approach heights are equal.

IF PickAndPlace_Enabled= TRUE THEN
    position.Position[0] := 450;
    position.Position[1] := -100;
    position.Position[2] := 150;
    position.Position[3] := -180;
    position.Position[4] := 180;
    position.Position[5] := -180;

    motionParams.Speed := 20;
    motionParams.Acceleration :=100;
    motionParams.Deceleration := 100;
    motionParams.SpeedLimit := 100;

    moveConfig.AbsoluteApproach :=FALSE;
    moveConfig.ApproachHeight :=50;

    PickAndPlace_Enabled:= FALSE;
END_IF;

//fbPickAndPlace will achieve to the target position while Depart, Approach and Move motion.

fbPickAndPlace(
    RobotData:=gRobotData,
    Execute:=execute,
    Position:=position,
    Blending:=blending,
    MotionParams:=motionParams,
    MoveConfig:=moveConfig);

execute:=FALSE;
```

[Exec_PickAndPlace_ToPos2]

```
//Setting Target position, operating parameters, operating configuration.

//Depart and Approach heights are equal.

IF PickAndPlace_Enabled= TRUE THEN
    position.Position[0] := 450;
    position.Position[1] := 100;
    position.Position[2] := 150;
    position.Position[3] := -180;
    position.Position[4] := 180;
    position.Position[5] := -180;

    motionParams.Speed := 20;
    motionParams.Acceleration :=100;
    motionParams.Deceleration :=100;
    motionParams.SpeedLimit := 100;

    moveConfig.AbsoluteApproach :=FALSE;
    moveConfig.ApproachHeight :=50;

    PickAndPlace_Enabled:= FALSE;
END_IF;

//fbPickAndPlace will achieve to the target position while Depart, Approach and Move motion.

fbPickAndPlace(
    RobotData:=gRobotData,
    Execute:=execute,
    Position:=position,
    Blending:=blending,
    MotionParams:=motionParams,
    MoveConfig:=moveConfig);

execute:=FALSE;
```

5.2. Creating Sample Programs

Adding Programs

Use this procedure to add names to your programs.

For the names of the programs, refer to *Program name* in 5.1 *Programming Overview*.

The following sections are described using the project file set in Sections 2 through 4 to create programs.

If you are continuing from Section 4 in one session, you do not need to import the project file created using steps 1 through 4.

- 1 Double-click the Sysmac Studio icon to start the Sysmac Studio.



- 2 Select **Import**.

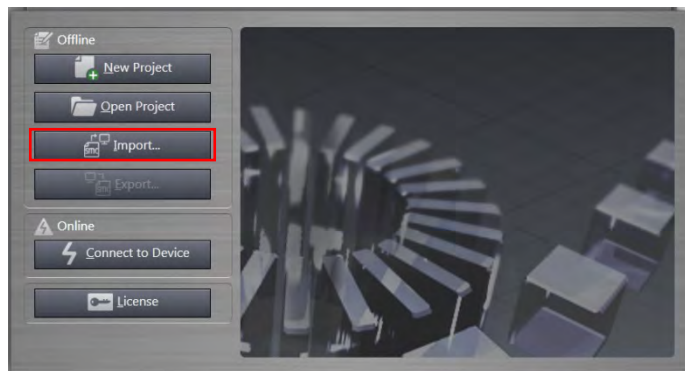

- 3 The **Import file** dialog appears. Select the exported project file created performing the procedures in Sections 2 through 4 and then click **Open**.

* Here, `omron_ePLC_EIP_V100` is selected.

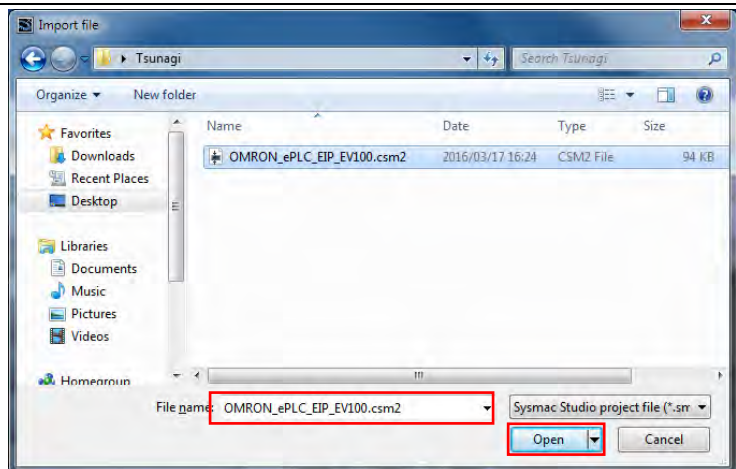

- 4 Start the project file.

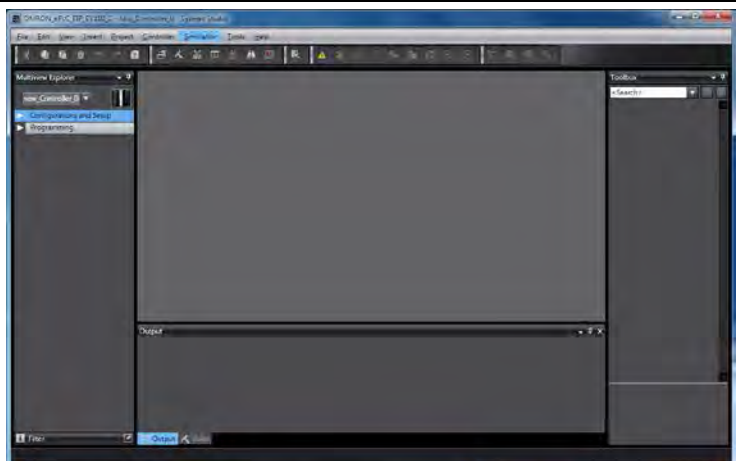

- 5 From the Multiview Explorer, select **Programming**, **POUs**, and then **Programs**. Right-click **Programs** and then select **Add** and **ST**.

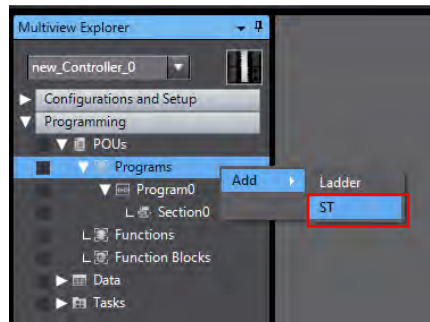

The pre-created ladder language **Program0** program is imported into the project file. This file will not be used in this program. Right-click the program and select **Delete** to delete.

- 6 The structured text **Program1** program is added under **Programs**.

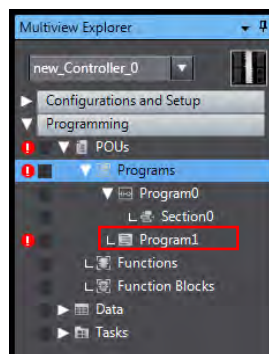

Adding this programs causes an error to appear. This error will clear while the program is created.

- 7 Select the added **Program1**. Right-click the program and select **Rename**.

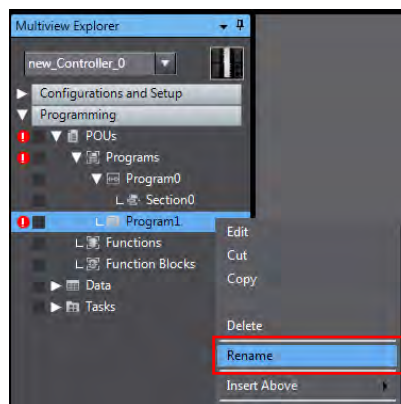

- 8 Enter the following program name:
• **GetMemory**

The program name has been successfully changed to **GetMemory**.

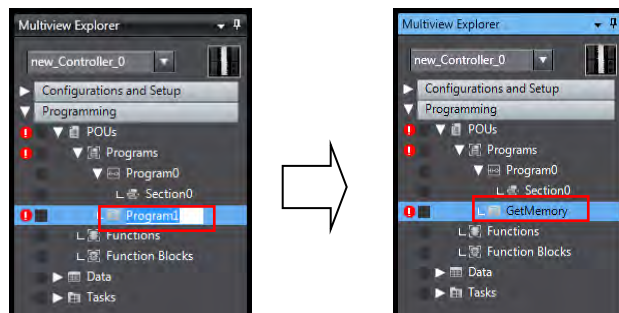

- 9 Repeat steps 5 through 8 to add four more ST programs and rename them as follows:
- ResetRobotError
 - Exec_RobotControl
 - Exec_PickAndPlace_ToPos1
 - Exec_PickAndPlace_ToPos2

The pre-created ladder language **Program0** program is imported into the project file. This file will not be used in this program. Right-click the program and select **Delete** to delete.

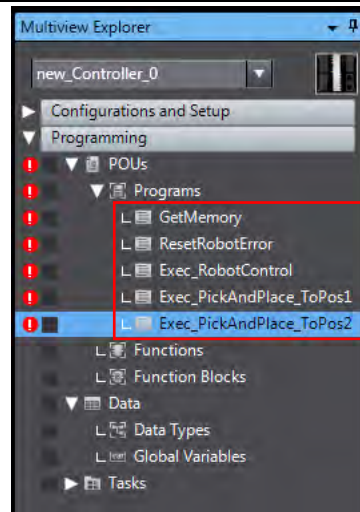

Creating Global Variables

Use the following procedure to register the global variables used in each program.

For the names of the global variables, refer to *Internal and External Variables* in 5.1 *Programming Overview*.

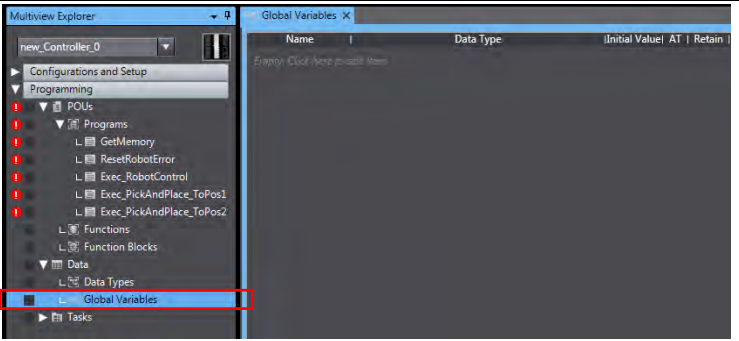
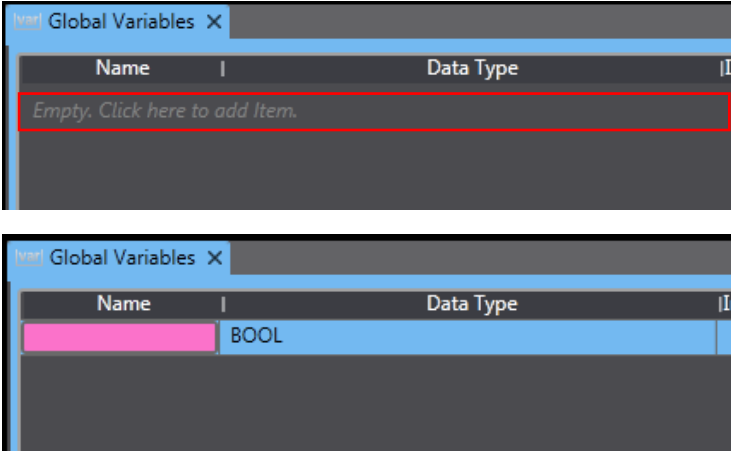
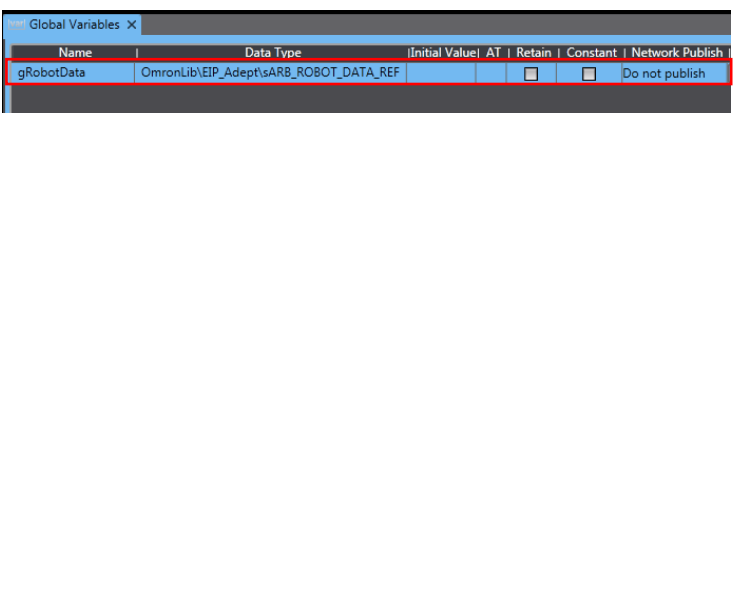
<p>1 Select Programming, Data and then double-click Global Variables.</p> <p>The global variable editor appears in the Edit window.</p>															
<p>2 Click anywhere in the Empty. Click here to add item.</p> <p>message to add a row.</p>															
<p>3 Enter the Name, Data Type, and Network Publish option for each variable listed in <i>Global variables</i> in 5.1 <i>Programming Overview</i>.</p> <p>Name gRobotData</p> <p>Data Type Omronlib\EIP_Adept\sARB_ROBOT_DATA_REF</p> <p>Network Publish Do not publish</p>	 <table border="1" data-bbox="708 1189 1450 1780"> <thead> <tr> <th>Name</th> <th>Data Type</th> <th>Initial Value</th> <th>AT</th> <th>Retain</th> <th>Constant</th> <th>Network Publish</th> </tr> </thead> <tbody> <tr> <td>gRobotData</td> <td>Omronlib\EIP_Adept\sARB_ROBOT_DATA_REF</td> <td></td> <td><input type="checkbox"/></td> <td><input type="checkbox"/></td> <td><input type="checkbox"/></td> <td>Do not publish</td> </tr> </tbody> </table>	Name	Data Type	Initial Value	AT	Retain	Constant	Network Publish	gRobotData	Omronlib\EIP_Adept\sARB_ROBOT_DATA_REF		<input type="checkbox"/>	<input type="checkbox"/>	<input type="checkbox"/>	Do not publish
Name	Data Type	Initial Value	AT	Retain	Constant	Network Publish									
gRobotData	Omronlib\EIP_Adept\sARB_ROBOT_DATA_REF		<input type="checkbox"/>	<input type="checkbox"/>	<input type="checkbox"/>	Do not publish									

4 Repeat steps 2 and 3 until all global variables are registered.

The global variables *from_Robot* and *to_Robot* are already registered in the project file created by performing the procedures described in Sections 2 through 4. These do not need to be registered here.

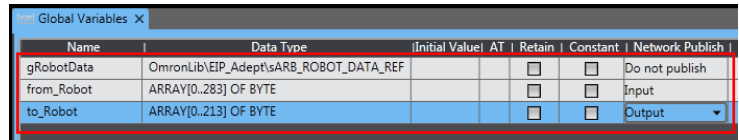
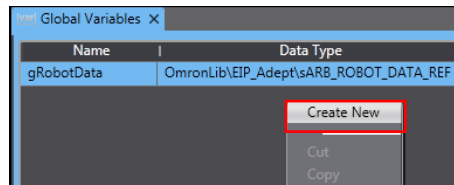

Registering Internal and External Variables

Use the following procedure to register the internal and external variables used in each program.

For the names of the global variables, refer to *Internal and External Variables* in 5.1 *Programming Overview*.

- 1 Select **Programming, POUs,** and **Programs,** and then double-click **Exec_RobotControl.**

The Exec_RobotControl editor appears in the **Edit** window.

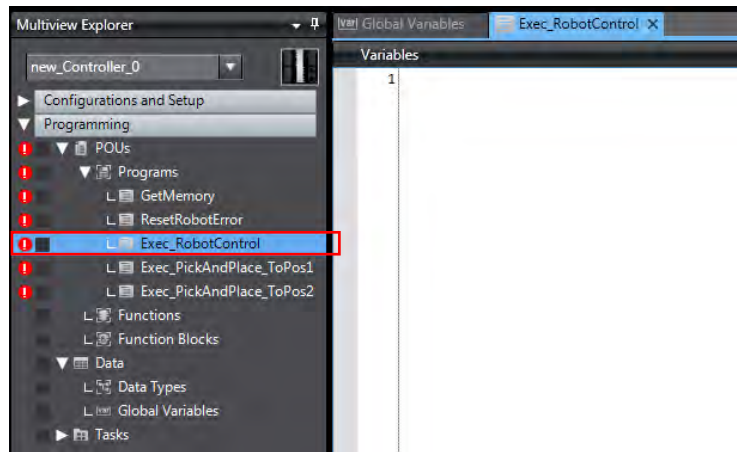

- 2 Click the **Variables** bar at the top of the editor to display the variable table.

Switch the display between internal and external variables in the variable table using the **Internals** and **Externals** tabs.

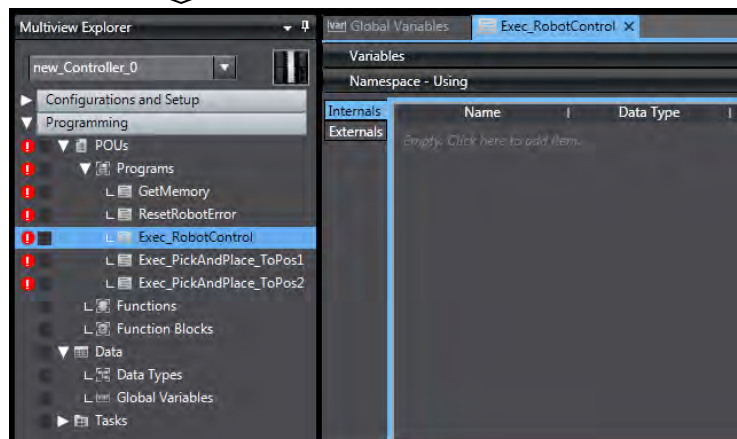
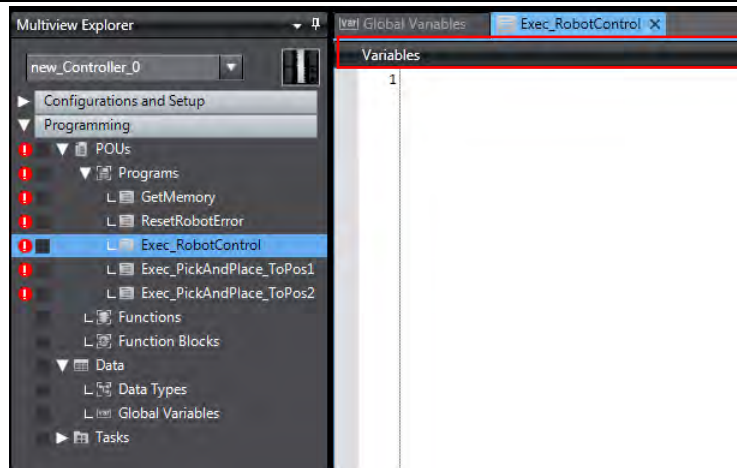

- 3 Click anywhere in the "Empty. Click here to add item." message to add a row.

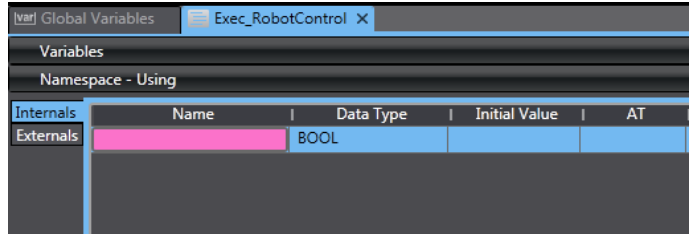
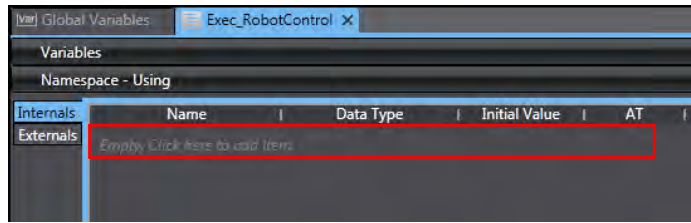

- 4 Enter the **Name**, **Data Type**, and **Initial Value** for each internal and external variable listed in *Internal and External Variables in 5.1 Programming Overview*.

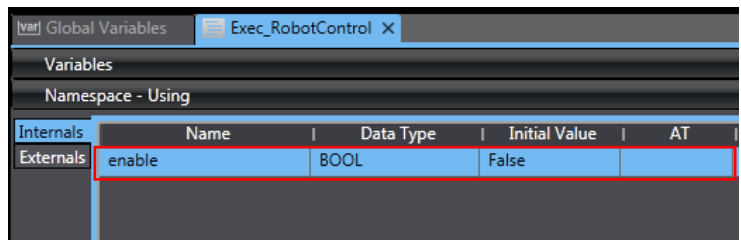

Name

enable

Data Type

BOOL

Initial Value

FALSE

- 5 Repeat steps 3 and 4 until all internal variables are registered into **Exec_RobotControl**.

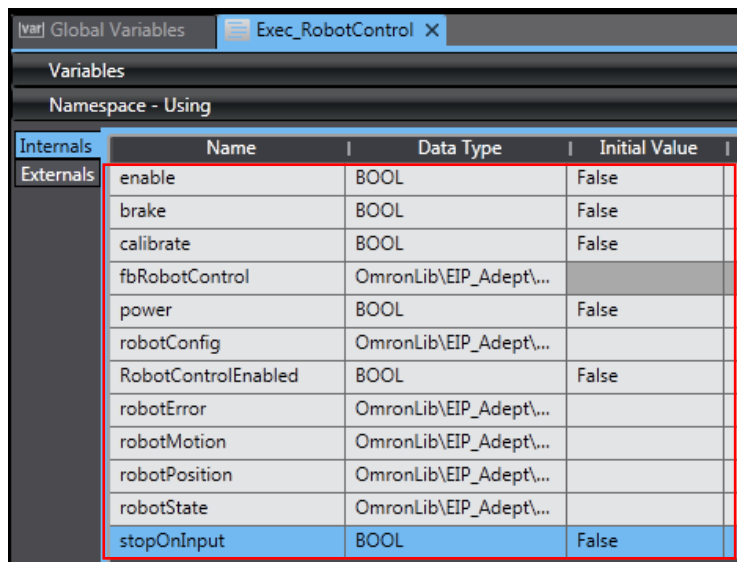

- 6 Click the **Externals** tab to change the display to external variables. Repeat steps 3 and 4 until all external variables are registered.

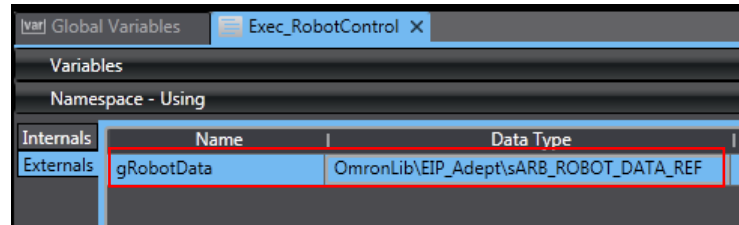
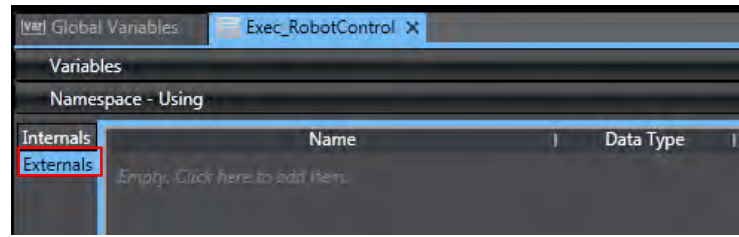

- 7 Repeat steps 1 through 6 to register all internal and external variables into other programs.

- GetMemory
- ResetRobotError
- Exec_PickAndPlace_ToPos1
- Exec_PickAndPlace_ToPos2

Writing Programs

Use the following procedure to write programs.

For the program code, refer to *Sample Programs* in *5.1 Programming Overview*.

This section uses the **Exec_RobotControl** program to describe the write procedure.

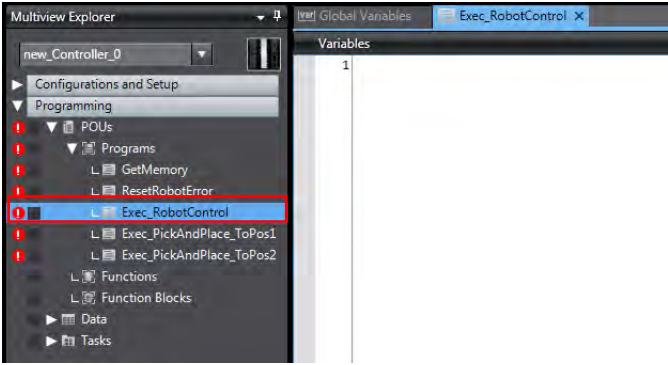
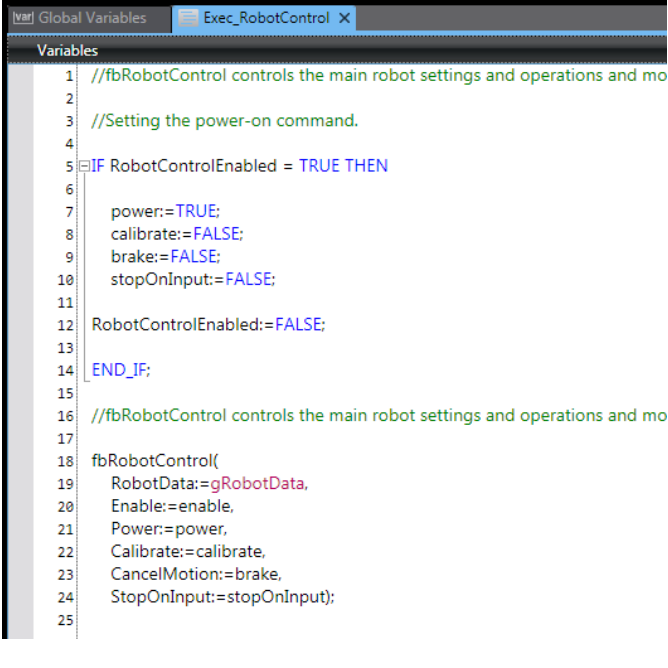
<p>1</p>	<p>From the Multiview Explorer, select Programming, POUs, and Programs, and then double-click Exec_RobotControl.</p> <p>The Structured Text program editor appears.</p>	 <p>The screenshot shows the 'Multiview Explorer' window with a tree view. Under 'Configurations and Setup', 'Programming' is expanded to show 'POUs', which is further expanded to 'Programs'. The 'Exec_RobotControl' program is highlighted with a red box. To the right, the 'Global Variables' window shows a single variable '1'.</p>
<p>2</p>	<p>Enter the code in <i>Sample Programs</i> in <i>5.1 Programming Overview</i>.</p> <p>Refer to <i>6-5-3 Structured Text Language</i> in the <i>NJ/NX-series CPU Unit Software User's Manual</i> (Cat. No. W501).</p>	 <pre>1 //fbRobotControl controls the main robot settings and operations and mo 2 3 //Setting the power-on command. 4 5 IF RobotControlEnabled = TRUE THEN 6 7 power:=TRUE; 8 calibrate:=FALSE; 9 brake:=FALSE; 10 stopOnInput:=FALSE; 11 12 RobotControlEnabled:=FALSE; 13 14 END_IF; 15 16 //fbRobotControl controls the main robot settings and operations and mo 17 18 fbRobotControl(19 RobotData:=gRobotData, 20 Enable:=enable, 21 Power:=power, 22 Calibrate:=calibrate, 23 CancelMotion:=brake, 24 StopOnInput:=stopOnInput); 25</pre>

3 After all variables and program code has been entered, perform a program check.

From the **Menu** bar, select **Project** and **Check All Programs** to perform a program check.

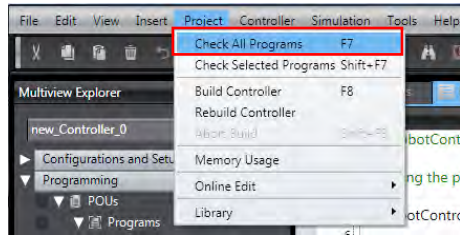

The check results for the **Exec_RobotControl** program appear in the **Build** window. Check the results for any errors.

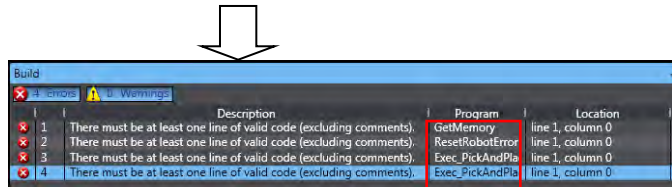

In the figure to the right, errors appear for other programs that have not been written yet. If any errors appear for **Exec_RobotControl** program, troubleshoot or edit the program in accordance with the error description to clear the error.

4 Repeat steps 1 through 3 to enter code and perform checks on all other programs.

- GetMemory
- ResetRobotError
- Exec_PickAndPlace_ToPos1
- Exec_PickAndPlace_ToPos2

Setting Tasks to Global Variables

Use the following procedure to set tasks to global variable.



Precautions for Correct Use

To maintain the concurrency of data in a tag data link, you must set a refreshing task for each global variable that is assigned to a tag.

- Maintaining Concurrency in the Tag Data in a Tag Set
- The timing of updating global variables that are assigned to tags is synchronized with the execution period of the user program that accesses the global variables.



Additional Information

A refreshing task maintains concurrency of the value of a global variable from all tasks that access that global variable. This is achieved by specifying a single task that can write to that global variable and not allowing any other task to write to that global variable.

Refer to the *NJ/NX-series CPU Unit Software User's Manual* (Cat. No. W501) for more information on refreshing tasks.

- 1 From the Multiview Explorer, select **Configurations and Setup**, and then double-click **Task Settings**.

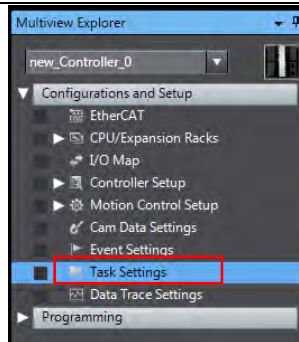

The **Task Settings** details screen appears in the **Edit** window.

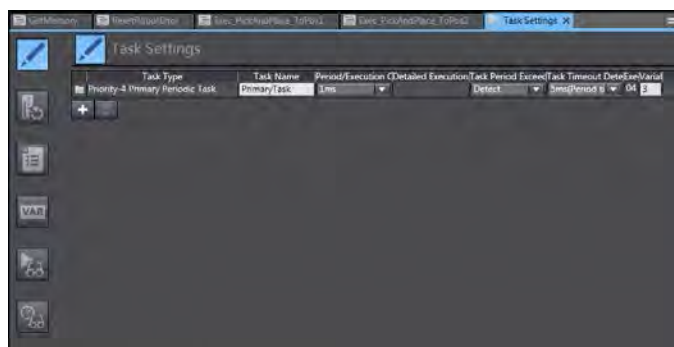

2

Select the  button on the left to display the **Settings for Exclusive Control of Variables in Tasks**.

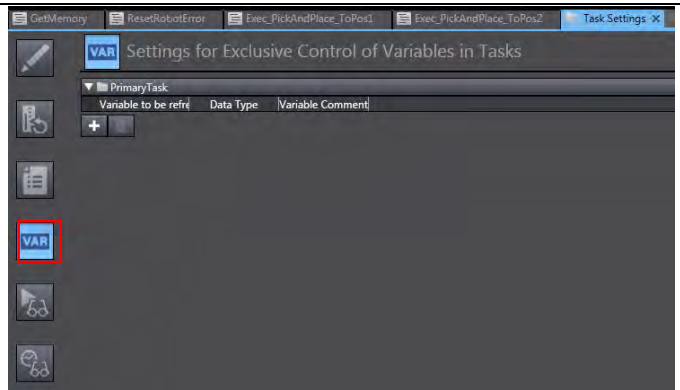

3

Click the [+] button to add a row.

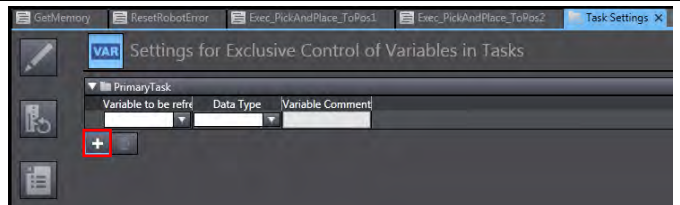

4

Select the global variable in the **Variable to be refreshed** menu. Click the down arrow to display the list of available global variables.

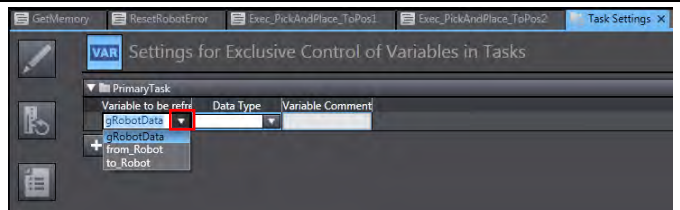

Select **to_Robot**.

Other input fields are automatically populated after selecting a variable.

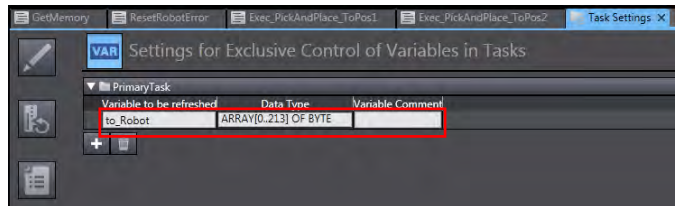

5

Repeat step 4 to register the **from_Robot** variable.

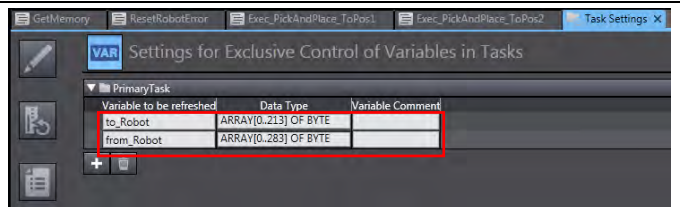

Set Tasks to Programs

Use the following procedure to set tasks to programs.



Precautions for Correct Use

To maintain the concurrency of data in a tag data link, you must set a refreshing task for each global variable that is assigned to a tag.

- Maintaining Concurrency in the Tag Data in a Tag Set
- The timing of updating global variables that are assigned to tags is synchronized with the execution period of the user program that accesses the global variables.



Additional Information

Refer to the *NJ/NX-series CPU Unit Built-in EtherNet/IP Port User's Manual (Cat. No. W506)* for more information on the concurrency of data in a tag data link.

- 1 From the Multiview Explorer, select **Configurations and Setup**, and then double-click **Task Settings**.

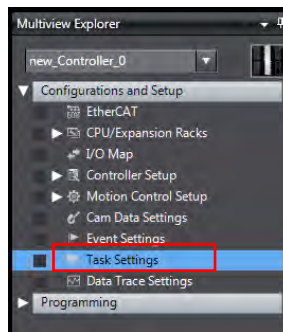

The **Task Settings** details screen appears in the **Edit** window.

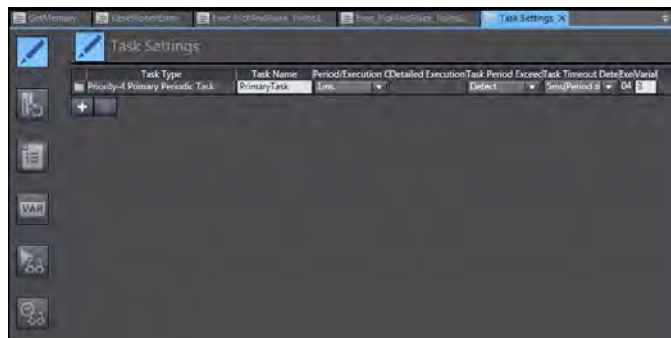

- 2 Click the  button on the left to display the **Program Assignment Settings**.

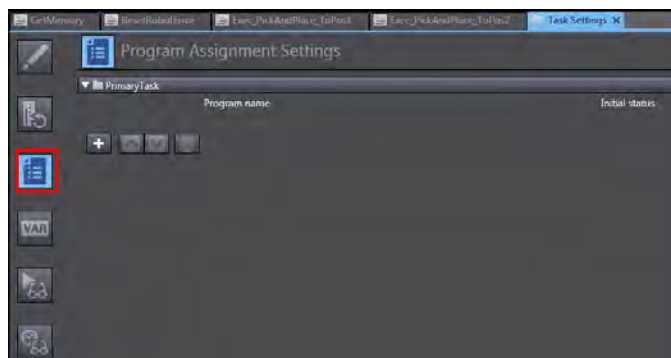

3 Click the [+] button to add a row.

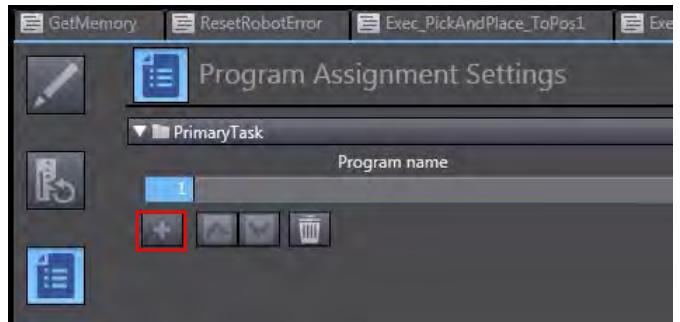

4 Set the program name.
Click the down arrow to display the list of available programs.

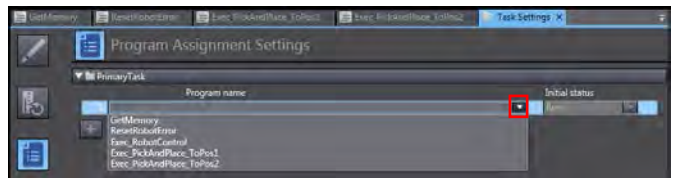

Select **GetMemory**.
Select **Run** under the **Initial Status** menu.

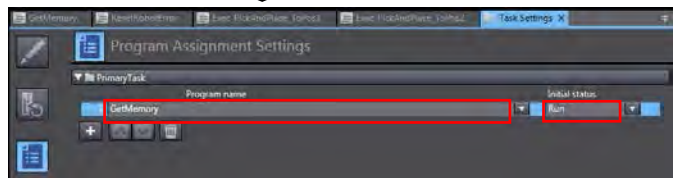

5 Repeat steps 3 through 4 to set all other programs.

- ResetRobotError
- Exec_RobotControl
- Exec_PickAndPlace_ToPos1
- Exec_PickAndPlace_ToPos2

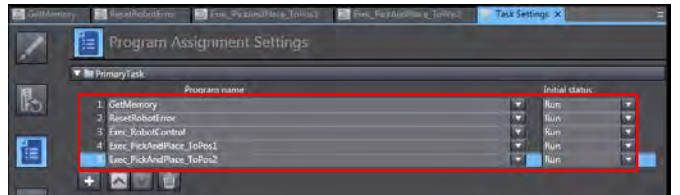

5.3. Debugging Programs

Caution

When function block programs are executed online, the Robot controller and the robot connected via EtherNet/IP™ may operate.

Perform the robot safety risk assessment and implement safety measures as necessary, such as reducing movement speed.



Transferring Programs

Use the following procedure to make an online connection, set programs and connections, and transfer project data to Controllers.

Refer to 7.3.6 *Transferring Project Data* in the Machine Automation Controller NJ-series EtherNet/IP™ Connection Guide OMRON Corporation Robot controllers (ePLC connections) (Cat. No. P649).

Debugging Programs

Use the following procedure to debug programs.

- 1 Double-click the **GetMemory** program to display the program.

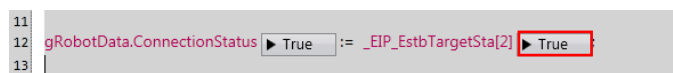
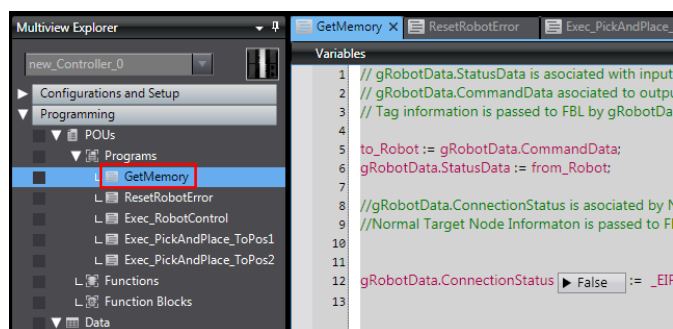

Confirm that the monitor value of **_EIP_EstbTargetSta[2]** is **TRUE**.

If the value is **FALSE**, the connection to the Adept robot is not established. Check for disconnected cables and recheck the IP address settings.

2 Double-click the **RobotResetError** program to display the program.

Confirm that the monitor value of **fbResetRobotError.enable** is **False**. Change the value to **True** by clicking the right arrow ► and then clicking **True**.

This clears the **EF** error that has been appearing on the Robot controller.

As the value of **fbResetRobotError.enable** is changed to **False** by the program, the **True** state cannot be verified.

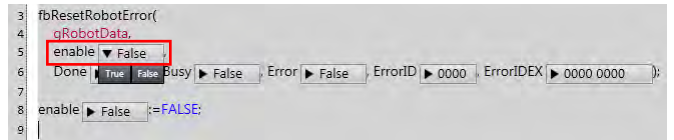
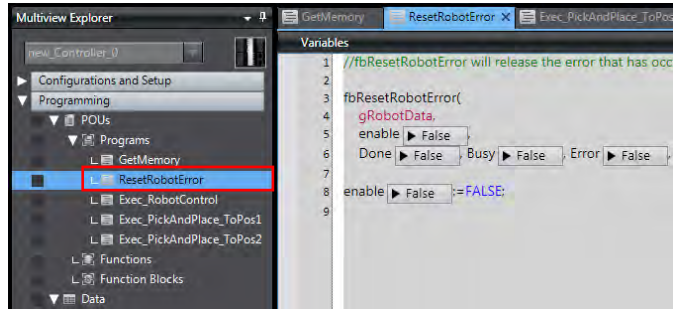

3 Double-click the **Exec_RobotControl** program to display the program.

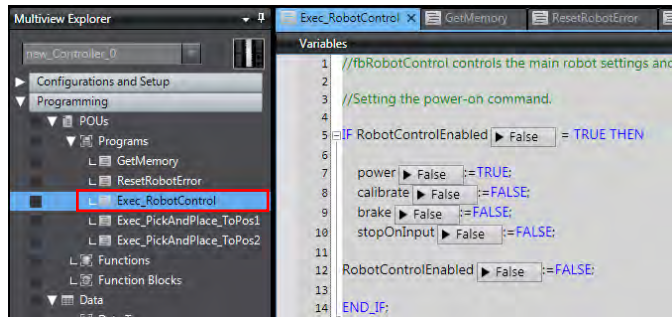

Confirm that the monitor value of **RobotControl_Enabled** is **False**. Change the value from **False** to **True** by clicking **▶**.

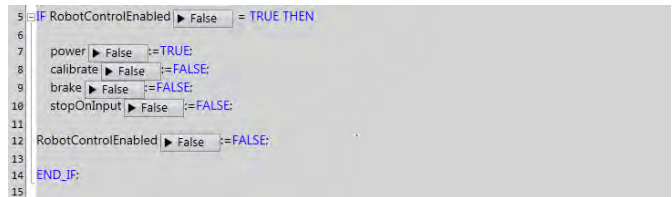

This sets the values for **power**, **calibrate**, and **stopOnInput**.

Confirm that the monitor value of power has changed to **True**.

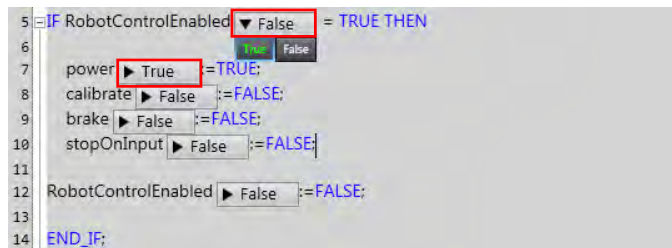

As the value of **RobotControl_Enabled** is changed to **FALSE** by the program, the **TRUE** state cannot be verified.

4 Next, confirm that the monitor value of **fbRobotControl.enable** is **False**. Change the value from **False** to **True** by clicking **▶**.

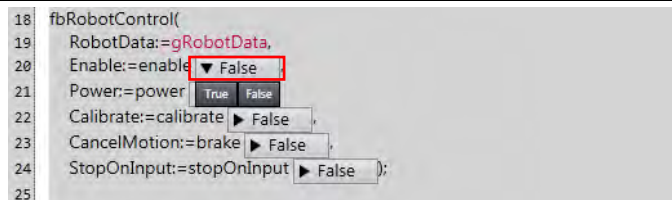

Confirm that the monitor value of **fbRobotControl.enable** has changed to **True**.

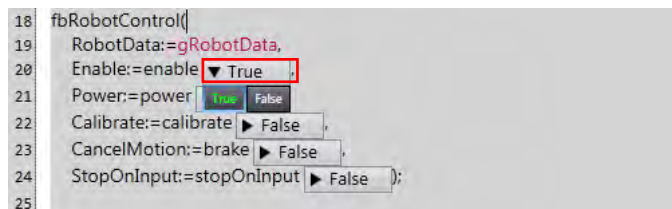

This turns on power to the robot.

5

Program name

Double-click the

Exec_PickAndPlace_ToPos1 program to display the program.

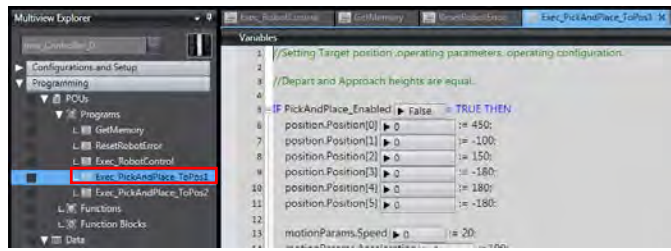

Confirm that the monitor value of **PickAndPlace_Enabled** is **False**. Change the value from **False** to **True** by clicking .

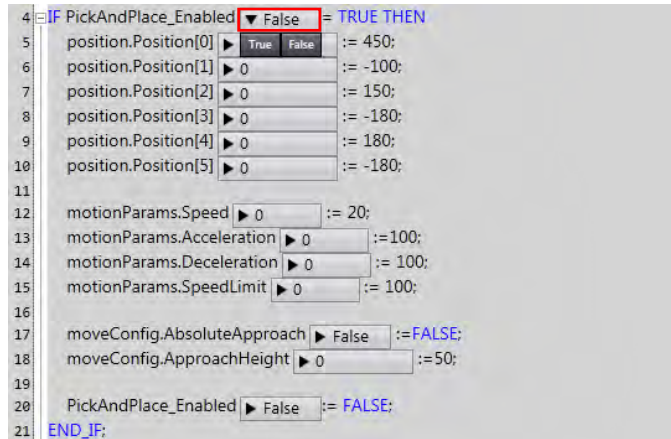

This sets the values for **position.Position[0-5]**, **motionParames.Speed**, **motionParames.Acceleration**, **motionParames.Deceleratoin**, **motionParames.SpeedLimit**, **moveConfig.AbsoluteApproach**, and **moveConfig.ApproachHeight**.

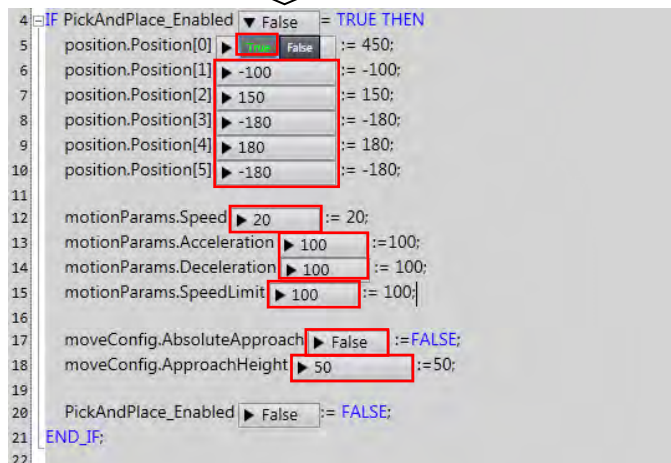

Confirm that all monitor values show their respective set values.

As the value of **RobotControl_Enabled** is changed to **FALSE** by the program, the **TRUE** state cannot be verified.

Caution

When function block programs are executed online, the Robot controller and robot connected via EtherNet/IP™ may operate.

Perform the robot safety risk assessment and implement safety measures as necessary, such as reducing movement speed.



Caution

The following operations will cause the robot to move.

Perform the robot safety risk assessment and implement safety measures as necessary before proceeding.



6 Next, confirm that the monitor value of **fbPickAndPlace.execute** is **False**.

```
25 fbPickAndPlace(  
26   RobotData:=gRobotData,  
27   Execute:=execute ▾ False  
28   Position:=position True False  
29   Blending:=blending ▶ False  
30   MotionParams:=motionParams,  
31   MoveConfig:=moveConfig);  
32  
33 execute ▶ False :=FALSE;  
34
```

Change the value from **False** to **True** by clicking ▶.

Confirm that the monitor value of **fbPickAndPlace.execute** has changed to **True**.

This causes the robot to move from the current position to Pos 1.

As the value of **fbPickAndPlace.execute** is changed to **FALSE** by the program, the **TRUE** state cannot be verified.



```
25 fbPickAndPlace(  
26   RobotData:=gRobotData,  
27   Execute:=execute ▾ False  
28   Position:=position True False  
29   Blending:=blending ▶ False  
30   MotionParams:=motionParams,  
31   MoveConfig:=moveConfig);  
32  
33 execute ▶ False :=FALSE;  
34
```

7

Program name

Double-click the

Exec_PickAndPlace_ToPos2

program to display the program.

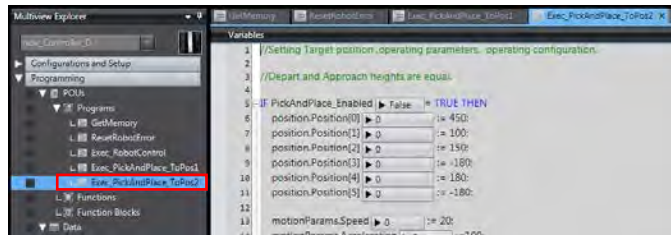

Confirm that the monitor value of **PickAndPlace_Enabled** is **False**.

Change the value from **False** to **True** by clicking .

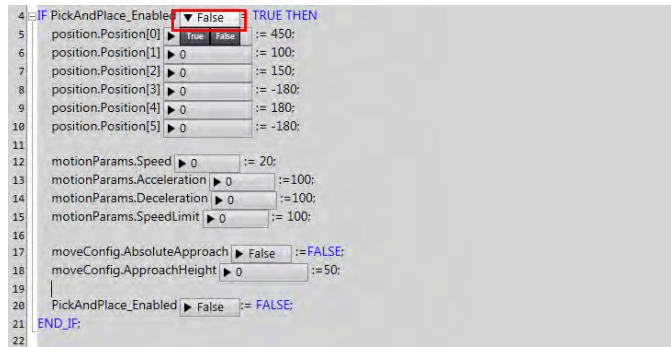

This sets the values for **position.Position[0-5]**, **motionParams.Speed**, **motionParams.Acceleration**, **motionParams.Deceleration**, **motionParams.SpeedLimit**, **moveConfig.AbsoluteApproach**, and **moveConfig.ApproachHeight**.

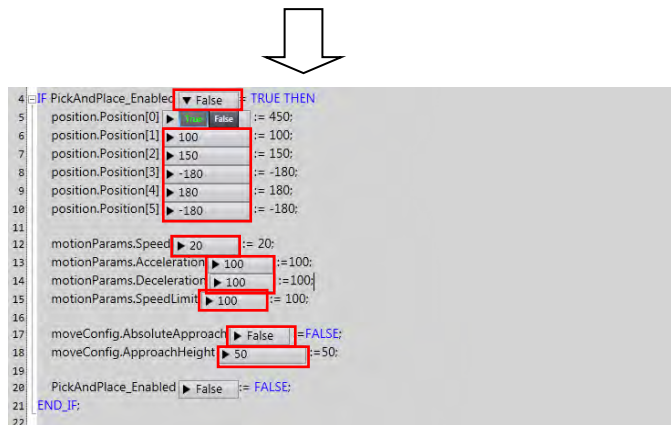

Confirm that all monitor values show their respective set values.

As the value of

PickAndPlace_Enabled is

changed to **FALSE** by the program,

the **TRUE** state cannot be verified.

Caution

When function block programs are executed online, the Robot controller and robot connected via EtherNet/IP™ may operate.

Perform the robot safety risk assessment and implement safety measures as necessary, such as reducing movement speed.



Caution

The following operations will cause the robot to move.

Perform the robot safety risk assessment and implement safety measures as necessary before proceeding.



8 Confirm that the monitor value of **PickAndPlace.execute** is **False**.

```
25 fbPickAndPlace(  
26   RobotData:=gRobotData,  
27   Execute:=execute, False  
28   Position:=position, True, False  
29   Blending:=blending, False  
30   MotionParams:=motionParams,  
31   MoveConfig:=moveConfig);  
32  
33 execute False :=FALSE;  
34
```



Change the value from **False** to **True** by clicking .

Confirm that the monitor value of **fbPickAndPlace.execute** has changed to **True**.

This causes the robot to move from Pos 1 to Pos 2.

As the value of **fbPickAndPlace.execute** is changed to **FALSE** by the program, the **TRUE** state cannot be verified.

```
25 fbPickAndPlace(  
26   RobotData:=gRobotData,  
27   Execute:=execute, True  
28   Position:=position, True, False  
29   Blending:=blending, False  
30   MotionParams:=motionParams,  
31   MoveConfig:=moveConfig);  
32  
33 execute False :=FALSE;  
34
```

6. Appendix - Initialization Method

This document was created on the basis that configurations are still at the default settings from the factory.

If using devices for which default settings have been changed, some of the configurations presented here may not proceed according to procedure.

6.1. Initializing Controllers

Initialize the CPU Unit to initialize the Controller.

Set the Controller operating mode to PROGRAM mode. From the **Menu** bar in Sysmac Studio, select **Controllers** and **Clear All Memory**. The **Clear All Memory** dialog box appears. Confirm the information and then click **OK**.

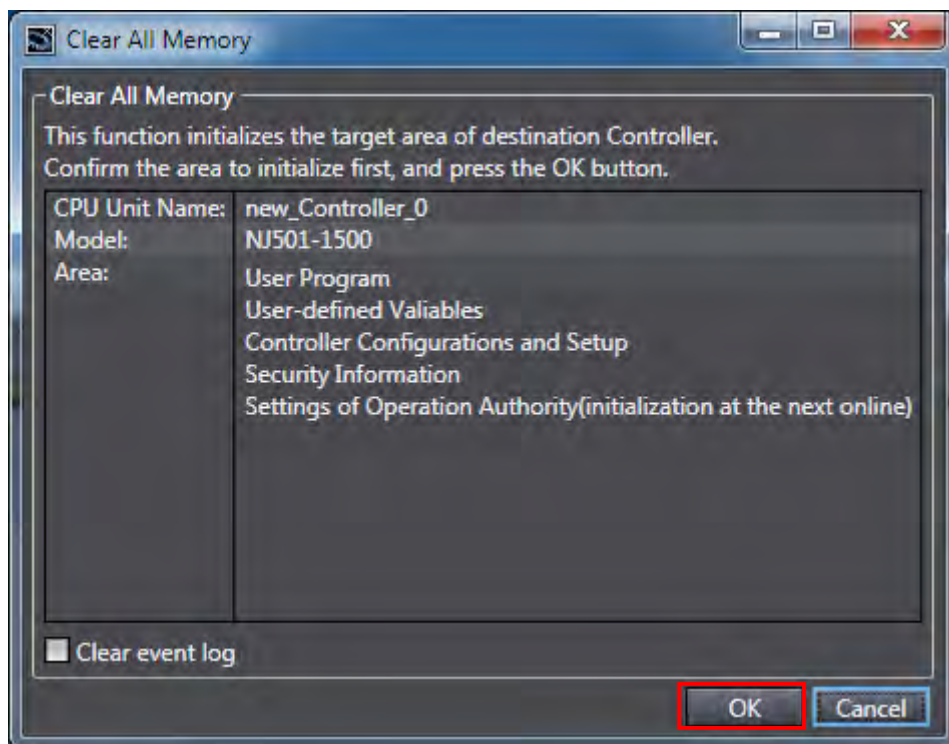

OMRON Corporation Industrial Automation Company

Tokyo, JAPAN

Contact: www.ia.omron.com

Regional Headquarters

OMRON EUROPE B.V.

Wegalaan 67-69, 2132 JD Hoofddorp
The Netherlands
Tel: (31)2356-81-300/Fax: (31)2356-81-388

OMRON ELECTRONICS LLC

2895 Greenspoint Parkway, Suite 200
Hoffman Estates, IL 60169 U.S.A
Tel: (1) 847-843-7900/Fax: (1) 847-843-7787

OMRON ASIA PACIFIC PTE. LTD.

No. 438A Alexandra Road # 05-05/08 (Lobby 2),
Alexandra Technopark,
Singapore 119967
Tel: (65) 6835-3011/Fax: (65) 6835-2711

OMRON (CHINA) CO., LTD.

Room 2211, Bank of China Tower,
200 Yin Cheng Zhong Road,
PuDong New Area, Shanghai, 200120, China
Tel: (86) 21-5037-2222/Fax: (86) 21-5037-2200

Authorized Distributor:

© OMRON Corporation 2016 All Rights Reserved.
In the interest of product improvement,
specifications are subject to change without notice.

Cat. No. **P103-E1-01**

0516-(0516)